

**/// PARKSIDE®**



[www.lidl-service.com](http://www.lidl-service.com)



## PRESSURE CLEANER PHD 150 B2

**GB**

### PRESSURE CLEANER

Translation of original operation manual

**RO**

### APARAT DE CURĂȚARE LA ÎNALTĂ PRESIUNE

Traducerea instrucțiunilor de utilizare originale

**DE AT CH**

### HOCHDRUCKREINIGER

Originalbetriebsanleitung

**HR**

### VIŠOKOTLAČNI ČISTAČ

Prijevod originalnih uputa za uporabu

**GR**

### ΠΛΥΣΤΙΚΟ ΜΗΧΑΝΗΜΑ ΥΨΗΛΗΣ ΠΙΕΣΗΣ

Μετάφραση των αυθεντικών οδηγιών λειτουργίας

IAN 78960

**HR RO GR**

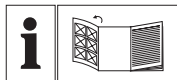

GB

Before reading, unfold the page containing the illustrations and familiarise yourself with all functions of the device.

---

HR

Prije nego što pročitate tekst, otvorite stranicu sa slikama i upoznaćite se na osnovu toga sa svim funkcijama uređaja.

---

RO

Înainte de a citi instrucțiunile, priviți imaginile și familiarizați-vă cu toate funcțiile aparatului.

---

GR

Πριν ξεκινήσετε την ανάγνωση, ανοίξτε τη σελίδα με τις εικόνες και εξοικειωθείτε με όλες τις λειτουργίες της συσκευής.

---

DE AT CH

Klappen Sie vor dem Lesen die Seite mit den Abbildungen aus und machen Sie sich anschließend mit allen Funktionen des Gerätes vertraut.

GB	Translation of original operation manual	Page	4
HR	Prijevod originalnih uputa za uporabu	Stranica	15
RO	Traducerea instrucțiunilor de utilizare originale	Pagina	26
GR	Μετάφραση των αυθεντικών οδηγιών λειτουργίας	Σελίδα	38
DE/AT/CH	Originalbetriebsanleitung	Seite	50

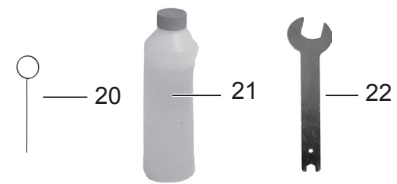
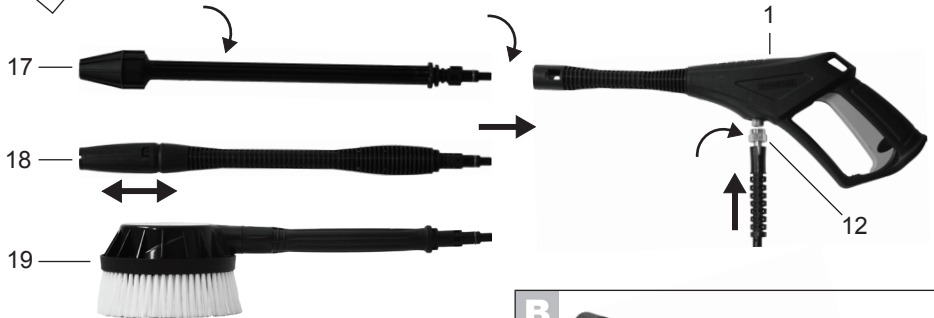
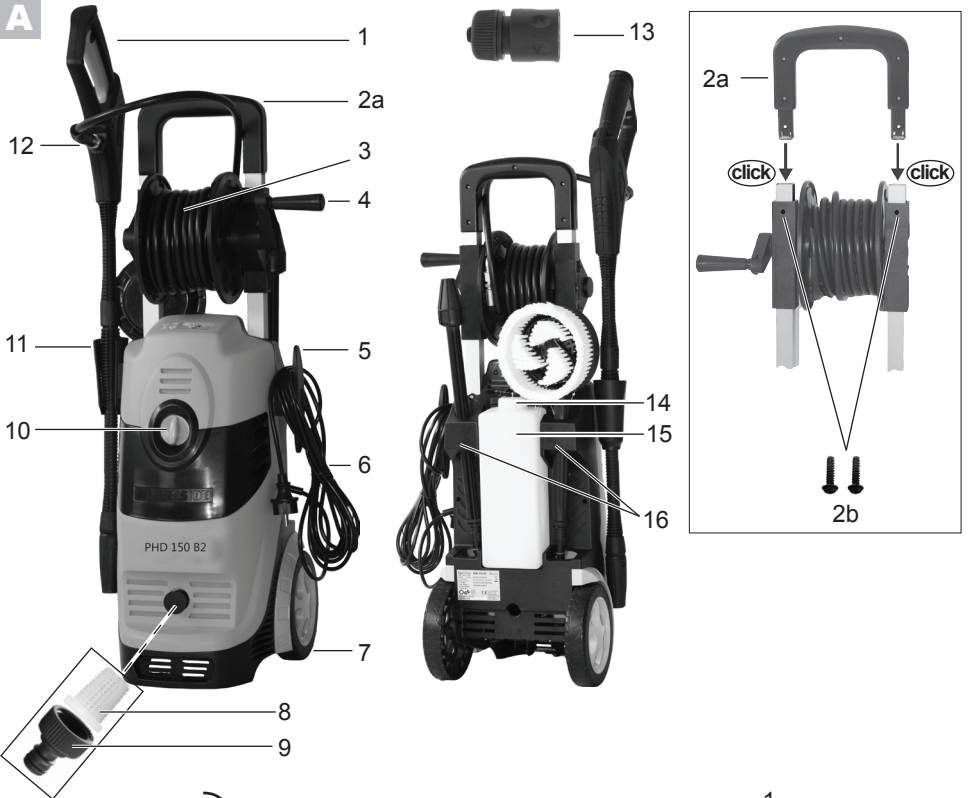
**A****B**

## Content

<b>Introduction .....</b>	<b>4</b>
<b>Areas of Application .....</b>	<b>4</b>
<b>General Description.....</b>	<b>5</b>
Scope of Delivery.....	5
Functional description .....	5
Overview.....	5
<b>Technical data .....</b>	<b>6</b>
<b>Notes on Safety .....</b>	<b>6</b>
Explanation of symbols .....	6
Symbols in the manual.....	7
General notes on safety .....	7
<b>Start-up .....</b>	<b>8</b>
Setting up .....	9
Mains connection.....	9
Operation .....	9
High-pressure / low-pressure operation .....	10
Interrupting operation .....	10
Ending operation .....	11
Using detergents .....	11
<b>Cleaning and Maintenance .....</b>	<b>11</b>
Cleaning.....	11
Maintenance .....	12
<b>Storage.....</b>	<b>12</b>
<b>Waste Disposal and Environ- mental Protection.....</b>	<b>12</b>
<b>Guarantee .....</b>	<b>12</b>
<b>Repair Service.....</b>	<b>13</b>
<b>Service-Center .....</b>	<b>13</b>
<b>Service Branch .....</b>	<b>13</b>
<b>Trouble shooting .....</b>	<b>14</b>
<b>Spare Parts Order .....</b>	<b>14</b>
<b>Translation of the original EC declaration of conformity .....</b>	<b>63</b>

## Introduction



Congratulations on the purchase of your new device. With it, you have chosen a high quality product.

The operating instructions constitute part of this product. They contain important information on safety, use and disposal.

Before using the product, familiarise yourself with all of the operating and safety instructions. Use the product only as described and for the applications specified. Keep this manual safely and in the event that the product is passed on, hand over all documents to the third party.

## Areas of Application

Only use the pressure cleaner in the following private home areas:

- This equipment is not suitable for commercial use.  
Commercial use will invalidate the guarantee.
- To clean machines, vehicles, buildings, work tools, facades, terraces, gardening tools, etc. with a high-pressure water jet.
- Only use with original accessories and spares.
- Cleaning the object according to its manufacturer's information.
- The rotating wash brush is fundamentally not suitable for sensitive and painted surfaces (e.g. automotive paint).

## General Description

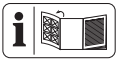

The diagram of the most important functional elements can be found on the foldout side.

### Scope of Delivery

Unpack the pressure cleaner and verify the contents:

- Pressure cleaner with mains cable
- Carrying handle with 2 attachment screws
- High-pressure hose on hose reel
- Holder for mains cable
- Jet gun holder
- Quick connector for garden hose adaptor
- Jet gun
- Turbo dirt blaster
- Standard Vario nozzle
- Rotating wash brush
- Nozzle cleaning needle
- 0.5 l cleaning agent
- Fork spanner
- Instruction Manual

Dispose of the packaging material correctly.

### Functional description

The pressure cleaner cleans by means of a water jet, with a choice of high or low pressure operation.

A detergent can be added if this is required.

For the functions of the operating elements please refer to the subsequent description.

Ensure that the safety instructions are always observed!

## Overview

- A** 1 Jet gun
- 2a Carrying handle
- 2b 2 attachment screws for carrying handle
- 3 High-pressure hose on hose reel
- 4 Hose reel crank
- 5 Holder for mains cable
- 6 Mains cable
- 7 Wheels
- 8 Strainer frame
- 9 Water connection
- 10 On/Off switch
- 11 Jet gun holder
- 12 High-pressure fitting (gun)
- 13 Quick connector for garden hose adaptor
- 14 Opening of cleaning agent tank
- 15 Cleaning agent tank
- 16 Accessories holder
- 17 Turbo dirt blaster
- 18 Standard Vario nozzle
- 19 Rotating wash brush
- 20 Nozzle cleaning needle
- 21 Cleaning agent
- 22 Fork spanner
- B** 23 Locking knob
- 24 Starting lever

## Technical data

### Pressure cleaner .....PHD 150 B2

Mains connection.....	230V~, 50 Hz
Power consumption .....	2100 W
Mains cable length.....	5 m
Weight (without accessories) .....	10.8 kg
Safety class .....	□ II
Degree of protection.....	IPX5
Rated/operating pressure (p) .....	11 MPa
Max. permissible pressure (p max) ...	15 MPa
Max. inflow pressure (p in max) ...	0.8 MPa
Max. inflow temperature (T in max) ...	40°C
Pumping rate, water (Q).....	5.5 l/min
Max. pumping rate, water (Q max) .....	7.5 l/min
Sound pressure level (L <sub>pA</sub> ) .....	78.2 dB(A); K <sub>pA</sub> = 3.0 dB(A)
Sound power level (L <sub>WA</sub> ) measured ...	91.7 dB(A); K <sub>WA</sub> = 3.0 dB(A)
guaranteed .....	98.0 dB(A)
Vibration (a <sub>n</sub> ) .....	0.496 m/s <sup>2</sup> ; K=1.5 m/s <sup>2</sup>

Do not exceed the maximum permitted network impedance of 0.277 Ohms at the electrical connection point.

The user must ensure that the device is operated only on a power supply network that fulfils this requirement.

If necessary, the local power supply company can be asked for the system impedance.

Technical and optical changes can be carried out in the course of further development without notice. All dimensions, references and information of this instruction manual are therefore without guarantee. Legal claims, which are made on the basis of the instruction manual, cannot thus be considered as valid.

## Notes on Safety

This section is concerned with the basic safety rules when working with the pressure cleaner.

### Explanation of symbols



Attention!



Before beginning work, familiarise yourself thoroughly with all the operating elements, particularly with how they function and operate. Ask a specialist if necessary.



Attention: Remove the plug from the socket as soon as the power lead is damaged or cut.

Also disconnect the plug from the socket when connecting to the water supply or trying to eliminate leaks.



The pressure cleaner is not suitable for direct connection to the drinking water supply system.



Safety class II



Electric appliances should not be disposed of in the domestic garbage.



**CAUTION.** pressure cleaners can be dangerous if they are not operated correctly! The jet must never be directed at people, animals, electric equipment connected to the power supply or against the actual pressure cleaner.

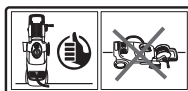

Operate the equipment only in an upright and never in a reclined position.

## Symbols in the manual



**Warning symbols with information on damage and injury prevention.**



Instruction symbols (the instruction can be explained at the place of the exclamation mark) with information on preventing damage.



Help symbols with information on improving tool handling.

## General notes on safety

- This appliance is not intended for use by persons (including children) with reduced physical, sensory or mental capabilities, or lack of experience and knowledge, unless they have been given supervision or instruction concerning use of the appliance by a person responsible for their safety.
- Children should be supervised to ensure that they do not play with the appliance.
- People who are unfamiliar with the operating instructions are not permitted to use the equipment. The operation of the equipment is not authorised for people under the age of 16.
- Use the equipment only when standing and on a level, stable base.
- Use the equipment only on a flat, stable surface.
- Do not direct the jet at yourself or others in order to clean clothes and shoes.
- To protect against water or dirt splashing back, wear suitable protective clothing and safety goggles.
- Do not operate the pressure cleaner when other people are in the immediate vicinity, other than they are also wearing protective clothes.
- Take appropriate measures to keep children away from the equipment whilst it is running.
- Do not use the equipment in the vicinity of flammable liquids or gases. Non-observance will result in a risk of fire or explosion.
- Do not spray combustible liquids. Risk of explosion.
- If you come into contact with cleaning agents, rinse with plenty of clean water.
- Store the equipment in a dry place and out of reach of children.



**Caution! To avoid damage to the equipment and any possible person injury resulting from this:**

## Working with the equipment



**Caution: to avoid accidents and injuries:**



**CAUTION.** pressure cleaners can be dangerous if they are not operated correctly! The jet must never be directed at people, animals, electric equipment connected to the power supply or against the actual pressure cleaner.

- Do not work with damaged or incomplete equipment, or with equipment that has been converted without the approval of the manufacturer. Before initial operation, have a specialist check that the required electrical protection measures are in place.
- Do not operate the equipment if the mains cable, water supply or other important parts such as the high-pressure hose or gun are damaged/leaking.
- Protect the pressure cleaner from frost and dry running.
- High-pressure hoses, fittings and

couplings are important for machine safety. Use only high-pressure hoses, fittings and couplings recommended by the manufacturer.

- Use only original accessories and do not carry out conversion work on the equipment.
- Please read the notes in the operating instructions on the topic of "maintenance and cleaning". Any measures above and beyond these, particularly opening the equipment, are to be carried out by an authorised electrician. In the case of repairs, always contact our service centre.

### Electrical safety:



#### Caution: to avoid accidents and injuries from electric shocks:

- The plug and socket of an extension cable must be water-tight!



Unsuitable extension cables can be dangerous as people can be harmed by an electric shock!

- Protect the electric plug connections against moisture.
- If there is a risk of flooding, fix the plug connections in an area that is safe from flooding.
- Ensure that the mains voltage matches the specifications on the rating plate.
- Connection to the mains must be carried out by an experienced electrician and meet the requirements of IEC 60364-1.
- The electrical installation shall be according to national wiring rules.
- The device must only be connected to a mains socket via a residual-current circuit breaker (RCD) with a rated leakage current of not more than 30 mA. Fuse: at least 13 ampere.

- Before each use, check the equipment, cable and plug for damage.
- If the power cable for this equipment is damaged, it must be replaced by the manufacturer, a customer service agent of the same or a similarly qualified person in order to prevent hazards.
- Do not pull the plug from the socket by the cable. Protect the cable from heat, oil and sharp edges.
- Do not carry or fix the equipment by the cable.
- Use only extension cables that are protected from spray water and designed for outdoor use. Always fully unroll a cable drum before use. Check the cable for damage.
- Before any work on the equipment, during work breaks and in the case of non-use, remove the plug from the socket.
- The cross-section of the power supply cable must not be less than  $2 \times 2,5 \text{ mm}^2$ .
- Wear sturdy footwear to protect against electric shock.
- To protect against electric shock, operate the equipment only in an upright position.

### Start-up



In keeping with current regulations a pressure cleaner must never be operated off the drinking water mains supply without a controllable backflow preventer. A suitable backflow preventer in conformity with EN 12729 type BA must be used.

Water that has passed through a backflow preventer is classified as undrinkable. A backflow preventer is available in specialist shops.

- Employ an ordinary garden hose for the water intake and ensure sufficient



- length.
- Use the device on a domestic water supply or a water source with a feed rate of at least 450l/h.

### Setting up

1. Push the carry handle (2a) into the square tube on the mounting frame. The carry handle (2a) audibly clicks into place. Fix the carry handle (2a) from the back using the two screws (2b) enclosed.
2. Slide the holder for mains cable (5) and the jet gun holder (11) onto the guides on the device housing.
3. Connect the high-pressure fitting (jet gun) (12) to the jet gun (1). Use the fork spanner from the package.
4. Connect the feed hose to the water supply and allow water to escape from the other end of the feed hose with no bubbles, in order to expel the air from the feed hose. Switch off the water tap.
5. Connect the supply hose to the water connection (9) on the equipment using the quick connector for garden hose adapter (13). Always use the filter insert (8) and clean this as required (bayonet fixing).
6. Plug in and turn the turbo dirt blaster (17) or the standard Vario nozzle (18) or the rotating wash brush (19) to connect to the jet gun (1).
7. To change the jet tube (17/18) or the rotating wash brush (19) push in the tube or brush and turn in the opposite direction.

### Mains connection

The pressure cleaner you have acquired is already fitted with a mains plug. The equipment is designed for connection to an earthed wall socket with a residual current operated device (RCD switch) at 230 V ~ 50 Hz.

 Only operate the pressure cleaner after all the above points have been observed.

1. Ensure that the pressure cleaner is turned off by its ON / OFF switch (10).
2. Insert the mains plug into the mains socket

### Operation

 **Be prepared for the recoil force of the emitted water jet! Ensure that you are standing firmly and that you are holding the gun (1) securely, otherwise you could injure yourself or other people.**

 Never operate the pressure cleaner with a closed water tap. Dry running will damage the pressure cleaner!

1. Turn on the water tap entirely.
  2. Switch on the pressure cleaner with the ON / OFF switch (10).  
Only ever switch on the pressure cleaner once you have connected all of the water pipes and they do not leak. The motor switches on until the required pressure has built up. After the pressure has built up, the motor switches off.
  3. Press the gun (1) starting lever (24). The nozzle operates by pressure and the motor switches back on. Releasing the starting lever (24) causes the equipment to switch off. The system remains pressurised.
- The turbo dirt blaster (17) produces a rotating water jet and is designed for low water consumption work.

- The standard Vario nozzle (18) produces a flat wide jet particularly suited for large surfaces.

Turn the tip of the nozzle left to reduce the width of the jet. Turn the tip of the nozzle right to expand the width of the jet.



**In the event of leaks in the water system, switch off the equipment immediately at the on/off switch (10) and disconnect the equipment from the mains at the mains power cord (6). Risk of electric shock! Start afresh with making the water connections (cf. "Start-up / Operation" from point 4.).**

**If there is still air in the device, please proceed as follows:**

**To vent the supply hose:**

1. Remove the quick connector for garden hose adaptor (13) on the water connection (9) and open the water tap until water comes out with no bubbles.
2. Switch off the water tap.
3. Connect the supply hose to the water connection (9) on the equipment using the quick connector for garden hose adapter (13).
4. Fully open the water tap.

**To vent the equipment:**

5. Switch on the on/off switch (10) until pressure has built up.
6. Switch off the on/off switch (10).
7. Press the on lever on the gun (1) until the pressure has gone.
8. Please repeat process 5. to 7. a few times until there is no more air in the device.

## High-pressure / low-pressure operation

The standard Vario nozzle (18) is designed for either high-pressure or low-pressure operation.

The standard Vario nozzle is set to high pressure by default.

Push the tip of the nozzle forward to change to low-pressure operation.

In this mode (low pressure), the unit will automatically draw in cleaning agent from the built-in tank (cf. "Using detergents").

Push in the tip of the nozzle to change to high-pressure operation.



- Lock / unlock the starting lever (24) of the gun (1) by depressing the locking knob (23).

**Lock the starting lever (24) to prevent the pressure cleaner from being inadvertently / accidentally started.**



Locked



Open

## Interrupting operation

- Release the lever of the gun (1).
- During prolonged work intervals turn off the pressure cleaner by its ON / OFF switch (10).



**If the equipment falls over, switch off the equipment immediately at the on/off switch (10) and disconnect the equipment from the mains at the mains power cord (6). Risk of electric shock! Only now should the**

**equipment be returned to an upright position. For your own safety, wait approx. 5 minutes before reconnecting to the electricity.**

## Ending operation

1. After having worked with a detergent rinse the pressure cleaner with clear water.
2. Release the lever of the gun (1).
3. Turn off the pressure by its ON / OFF switch (10). Disconnect the mains plug.
4. Turn off the water tap.
5. Disconnect the pressure cleaner from the water mains.
6. Pull the lever of the gun (1) to vent the pressure existing within the system.

## Using detergents

The pressure cleaner was designed for operation with a neutral detergent based on a biologically decomposable anionic tenside. Other detergents or chemical substances could impair the safety of the pressure cleaner and damage it. Such damage to the equipment is not covered by the guarantee.

### Fill/drain detergent:

- To add cleaning agent to the jet, you must first fill the cleaning agent tank (15).
- To remove the cleaning agent tank (15), hold it on the side and push it upwards. You can now pull the cleaning agent tank out of the bottom and side guides on the pressure cleaner. Mind to first remove the induction hose and the cap from the opening of the cleaning agent tank (14) as they will remain on the pressure cleaner.
- To reinstall the cleaning agent tank (15), trace back the above steps.

### Working Instructions:

- Operate the standard Vario nozzle (18) in low-pressure mode to automatically add cleaning agent to the water.
- The rotating wash brush (19) is always in low-pressure mode and cleaning agent will thus always be added to the water.
- To operate the rotating wash brush (19) without any cleaning agent, remove the cleaning agent tank (15).

## Cleaning and Maintenance



Pull out the power plug before every maintenance operation. This also includes connecting to the water supply or trying to eliminate leaks. There is a risk of electrocution or of injury from moving parts.

## Cleaning



**Never direct the water jet against the pressure cleaner, nor clean the pressure cleaner under flowing water. This could give rise to the danger of electric shock and damage the pressure cleaner!**

**Always keep the pressure cleaner clean. Do not use any detergents or solvents.**

- Always keep the ventilation slots clean and free.
- Only clean the pressure cleaner with a soft brush or a slightly moist cloth.
- In case a nozzle of the jet tube (17/18) is clogged up, use the nozzle cleaning needle (21) to remove the object from the nozzle.

## Maintenance

The pressure cleaner is maintenance free.



**Ask our service centre to carry out any work that is not described in these instructions. Use only original parts.**

## Storage

- Drain all the water from the pressure cleaner.  
Disconnect the unit from the water supply. Press the On/Off switch (10) to turn on the pressure cleaner for no longer than 1 minute until no more water escapes from the jet gun(1) or from the attaching parts (17/18/19). Turn off the unit.
- Protect the pressure cleaner and its accessories from frost when they have not been completely drained of all water.
- Store the pressure cleaner and its accessories in a frost-free room.

## Waste Disposal and Environmental Protection

Be environmentally friendly. Return the tool, accessories and packaging to a recycling centre when you have finished with them.



Electric appliances should not be disposed of in the domestic garbage.

Hand the tool in at a recycling centre. The plastics and metal parts can be separated and recycled. Ask your Service Center about this.

## Guarantee

Dear Customer,

This equipment is provided with a 3-year guarantee from the date of purchase.

In case of defects, you have statutory rights against the seller of the product. These statutory rights are not restricted by our guarantee presented below.

### Terms of Guarantee

The term of the guarantee begins on the date of purchase. Please retain the original receipt. This document is required as proof of purchase.

If a material or manufacturing defect occurs within three years of the date of purchase of this product, we will repair or replace – at our choice – the product for you free of charge. This guarantee requires the defective equipment and proof of purchase to be presented within the three-year period with a brief written description of what constitutes the defect and when it occurred.

If the defect is covered by our guarantee, you will receive either the repaired product or a new product. No new guarantee period begins on repair or replacement of the product.

### Guarantee Period and Statutory Claims for Defects

The guarantee period is not extended by the guarantee service. This also applies for replaced or repaired parts. Any damages and defects already present at the time of purchase must be reported immediately after unpacking. Repairs arising after expiry of the guarantee period are chargeable.

### Guarantee Cover

The equipment has been carefully produced in accordance with strict quality guidelines and conscientiously checked prior to delivery.

The guarantee applies for all material and manufacturing defects. This guarantee does not extend to cover product parts that are subject to normal wear and may therefore be considered as wearing parts (e.g. filters or attachments) or to cover damage to breakable parts (e.g. switches, batteries, or parts made of glass).

This guarantee shall be invalid if the product has been damaged, used incorrectly or not maintained. Precise adherence to all of the instructions specified in the operating manual is required for proper use of the product. Intended uses and actions against which the operating manual advises or warns must be categorically avoided. The product is designed only for private and not commercial use. The guarantee will be invalidated in case of misuse or improper handling, use of force, or interventions not undertaken by our authorised service branch.

### Processing in Case of Guarantee

To ensure efficient handling of your query, please follow the directions below:

- Please have the receipt and item number (e.g. IAN 12345) ready as proof of purchase for all enquiries.
- Please find the item number on the rating plate, an engraved plate on the front page of your manual (bottom left) or as a sticker on the back or bottom.
- Should functional errors or other defects occur, please initially contact the service department specified below by **telephone** or by **e-mail**. You will then receive further information on the processing of your complaint.
- After consultation with our customer service, a product recorded as defective can be sent postage paid to the service address communicated to you, with the proof of purchase (receipt) and specification of what constitutes the defect and when it occurred. In order to avoid acceptance problems and additional

costs, please be sure to use only the address communicated to you. Ensure that the consignment is not sent carriage forward or by bulky goods, express or other special freight. Please send the equipment inc. all accessories supplied at the time of purchase and ensure adequate, safe transport packaging.

## Repair Service

For a charge, repairs not covered by the guarantee can be carried out by our service branch, which will be happy to issue a cost estimate for you.

We can handle only equipment that has been sent with adequate packaging and postage.

**Attention:** Please send your equipment to our service branch in clean condition and with an indication of the defect.

Equipment sent carriage forward or by bulky goods, express or other special freight will not be accepted.

We will dispose of your defective devices free of charge when you send them to us.



## Service-Center

### Service Great Britain

Tel.: 0871 5000 720

(£ 0.10/Min.)

E-Mail: [grizzly@lidl.co.uk](mailto:grizzly@lidl.co.uk)

**IAN 78960**



## Service Branch

Please note that the following address is not a service address. Please initially contact the service centre specified above.

### DES UK Ltd.

Unit B7

Oxford Street Industrial Park

Vulcan Road

Bilston, West Midlands WV14 7LF

## Trouble shooting

Problem	Possible cause	Remedy
Pressure cleaner is not operating	ON / OFF switch (10) is turned off	Check ON / OFF switch (10)
	Damaged power supply cable (6)	Switch off the equipment and disconnect from the mains. Check power supply cable (6) for damage. If necessary have the power supply cable (6) replaced by a qualified electrician.
	Mains fault	Check the electrical system for conformity with the data on the rating plate.
Pressure cleaner does not generate any pressure	Air trapped in the pressure cleaner	Switch on the equipment with the jet gun and with no nozzle until bubble-free water comes out.
	Drop in the water mains pressure	Check the water mains.
Severe pressure fluctuations	High-pressure nozzle (17) is dirty	Rinse the high-pressure nozzle (17) with water. If necessary clean the nozzle hole with a needle.
Leaks in the water system	Connections not fitted correctly	Switch off the equipment and disconnect from the mains. Reconnect the equipment to the water pipes (cf. "Initial Operation/Set-Up")
	Water connection (9) leaks	Switch off the equipment and disconnect from the mains. Replace the water connection (9) inc. gasket (cf. "Spare Parts")

## Spare Parts Order

When buying parts for the pressure cleaner, use the service address given. Please enter your machine type and the item number of the part you are ordering.

A	Item	Description.....	Product No.
	1	Jet gun .....	91097399
	3	High-pressure hose.....	91097400
	13	Quick connector for garden hose adaptor .....	91097401
	17	Turbo dirt blaster .....	91097403
	18	Standard Vario nozzle.....	91097404
	19	Rotating wash brush.....	91097405
	9	Water connection w/ strainer frame.....	91097408

## Sadržaj

<b>Uvod</b> .....	<b>15</b>
<b>Svrha primjene</b> .....	<b>15</b>
<b>Opći opis</b> .....	<b>16</b>
Opseg isporuke .....	16
Opis funkcije .....	16
Pregled .....	16
<b>Tehnički podaci</b> .....	<b>17</b>
<b>Sigurnosne upute</b> .....	<b>17</b>
Slikovni znakovi na uređaju.....	17
Simboli u Uputi .....	18
Opće sigurnosne upute .....	18
<b>Puštanje u pogon</b> .....	<b>19</b>
Postavljanje .....	19
Mrežni priključak .....	20
Pogon .....	20
Visokotlačni / niskotlačni pogon .....	21
Prekid pogona .....	21
Završetak pogona .....	21
Primjena sredstava za čišćenje .....	21
<b>Čišćenje i Održavanje</b> .....	<b>22</b>
Čišćenje.....	22
Održavanje .....	22
<b>Pohranjivanje</b> .....	<b>22</b>
<b>Uklanjanje/zaštita okoliša</b> .....	<b>22</b>
<b>Traženje grešaka</b> .....	<b>23</b>
<b>Rezervni dijelovi</b> .....	<b>23</b>
<b>Garancija</b> .....	<b>24</b>
<b>Servis za popravke</b> .....	<b>25</b>
<b>Service-Center</b> .....	<b>25</b>
<b>Servisna poslovница</b> .....	<b>25</b>
<b>Prijevod originalne CE Izjave o podudarnosti</b> .....	<b>63</b>

## Uvod



Srdačno Vam čestitamo na kupnji Vašega novog uređaja. Time ste se Vi odlučili za jedan visokokvalitetni proizvod. Uputa za upravljanje sastavni je dio ovoga proizvoda. Ona sadrži važne upute za sigurnost, uporabu i uklanjanje. Prije korištenja proizvoda upoznajete se sa svim uputama za upravljanje i sigurnost. Proizvod koristite samo kako je opisano i za navedena područja primjene. Dobro sačuvajte Uputu i pri predaji proizvoda trećim osobama uručite i svu dokumentaciju.

## Svrha primjene

Ovaj visokotlačni uređaj za čišćenje koristite isključivo za privatno kućanstvo:

- Ovaj uređaj nije prikladan za obrtničku uporabu. Kod obrtničke uporabe gubi se garancija.
- Za čišćenje strojeva, vozila, građevina, alata, fasada, terasa, vrtnih uređaja itd. visokotlačnim vodenim mlazom.
- S originalnim dijelovima pribora i rezervnim dijelovima.
- Uz pridržavanje podataka proizvođača objekta, koji se mora očistiti.
- Za osjetljive i lakirane površine (npr. autolak) rotirajuća četka načelno nije prikladna.

## Opći opis

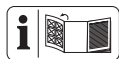

Sliku najvažnijih funkcionalnih dijelova naći ćete na preklapljenoj stranici.

## Opseg isporuke

Raspakirajte uređaj i provjerite opseg isporuke:

- Visokotlačni uređaj za čišćenje s vodom mrežnog priključka
- Visokotlačno crijevo na bubnju za crijevo
- Ručka za nošenje + 2 vijka
- Kuka za kabel
- Držać pištolja za prskanje
- Brzi priključak za adapter za vrtno crijevo
- Pištolj za prskanje
- Mlazna cijev s visokotlačnom mlaznicom (freza turbo pentru mizerie)
- Mlazna cijev s mlaznicom s ravnim mlazom (duža standard vario)
- Rotirajuća četka
- Igla za čišćenje mlaznice
- 0,5 l sredstva za čišćenje
- Vilasti ključ
- Uputa za posluživanje

Propisno uklonite materijal za pakiranje.

## Opis funkcije

Visokotlačni uređaj za čišćenje čisti pomoću vodenog mlaza, po izboru u području visokog ili niskog tlaka.

Prema potrebi s dodatkom sredstava za čišćenje.

Funkciju upravljačkih dijelova molimo pročitajte u sljedećim opisima. Pridržavajte se sigurnosnih uputa.

## Pregled

- |          |  |
|----------|--|
| <b>A</b> | 1 Pištolj za prskanje  |
|          | 2a Ručka za nošenje  |
|          | 2b 2 vijka   |
|          | 3 Visokotlačno crijevo na bubnju za crijevo                            |
|          | 4 Ručica za bubanj za crijevo  |
|          | 5 Kuka za kabel  |
|          | 6 Vod mrežnog priključka   |
|          | 7 Kotači   |
|          | 8 Sitasti umetak   |
|          | 9 Priključak vode  |
|          | 10 Uključivač/isključivač  |
|          | 11 Držać pištolja za prskanje  |
|          | 12 Visokotlačni priključak na strani pištolja                          |
|          | 13 Brzi priključak za adapter za vrtno crijevo                         |
|          | 14 Otvor spremnika za sredstvo za čišćenje                             |
|          | 15 Spremnik za sredstvo za čišćenje                                    |
|          | 16 Držać pribora   |
|          | 17 Mlazna cijev s visokotlačnom mlaznicom (freza turbo pentru mizerie) |
|          | 18 Mlazna cijev s mlaznicom s ravnim mlazom (duža standard vario)      |
|          | 19 Rotirajuća četka  |
|          | 20 Igla za čišćenje mlaznice   |
|          | 21 Sredstvo za čišćenje  |
|          | 22 Vilasti ključ   |
| <b>B</b> | 23 Blokirni gumb   |
|          | 24 Ručka za uključenje   |



## Tehnički podaci

### Uređaj .....PHD 150 B2

Nazivni ulazni napon.....	230V~, 50 Hz
Prijem snage.....	2100 W
Duljina mrežnog kabela.....	5 m
Težina.....	10,8 kg
Klasa zaštite.....	□ II
Vrsta zaštite.....	IPX5
Odnosni tlak/radni tlak (p).....	11 MPa
Maks. dopušteni tlak (p max).....	15 MPa
Dovodni tlak (p in max).....	0,8 MPa
Maks. dovodna temperatura (T in max).....	40°C
Transportna količina, voda (Q)..	5,5 l/min.
Maks. transportna količina (Q max).....	7,5 l/min.
Razina zvučnog tlaka ( $L_{pA}$ ).....	78,2 dB(A); $K_{pA} = 3,0$ dB(A)
Razina snage zvuka ( $L_{WA}$ ) izmjereni.....	91,7 dB(A); $K_{WA} = 3,0$ dB(A)
zajamčeni.....	98,0 dB(A)
Vibracijska $a_n$ .....	0,496 m/s <sup>2</sup> ; $K=1,5$ m/s <sup>2</sup>

Ezt a készüléket egy az átadási ponton (házi bekötés) maximum 0,277 Ohm  $Z_{max}$  rendszerimpedanciájú áramellátó hálózatra tervezték.

A felhasználónak meg kell győződnie arról, hogy a készüléket csak olyan áramellátó hálózatról üzemeltetik, amely ezen feltételeknek megfelel. Amennyiben szükséges, a rendszerimpedancia iránt a helyi energiaellátó vállalatnál lehet érdeklődni.

Tehničke i optičke izmjene mogu se poduzeti bez najave u okviru daljnjeg razvoja. Stoga ne jamčimo za mjere, upute i podatke u ovoj Uputi za posluživanje. Stoga se ne mogu ostvariti pravni zahtjevi, koji se podnose na temelju Upute za posluživanje.

## Sigurnosne upute

Ovaj odjeljak obrađuje osnovne sigurnosne propise pri radu s visokotlačnim uređajem za čišćenje.

## Slikovni znakovi na uređaju



Pozor!



Prije početka rada dobro se upoznajte sa svim elementima za posluživanje, osobito s funkcijama i načinima djelovanja. Prema potrebi pitajte neku stručnu osobu. Pročitajte i pridržavajte se Upute za posluživanje koja pripada uređaju!



Pozor! Kod oštećenja ili prerezanog mrežnog kabela odmah izvucite utikač iz utičnice.

Izvucite i utikač iz utičnice pri priključku na dovod vode ili pri pokušaju odstranjivanja nezaptivenosti.



Uređaj, koji nije prikladan za priključak na postrojenje za opskrbu pitkom vodom.



Klasa zaštite II



Uređaji ne spadaju u kućno smeće.



Visokotlačni uređaji za čišćenje mogu biti opasni kod nestručne uporabe. Mlaz se ne smije usmjeriti na ljude, životinje, aktivnu električnu opremu ili na sam uređaj.



Uređajem radite samo u stojećem, nikad u ležećem položaju.



Hrvatska oznaka ispitivanja konformnosti.

Izjava o sukladnosti za ovaj proizvod dostupna je na internet stranici [www.lidl.hr](http://www.lidl.hr).

## Simboli u Uputi



**Znakovi opasnosti s podacima o zaštiti od materijalnih ili oštećenja osoba.**



Znakovi naredbe (umjesto uskličnika naredba je objašnjena) s podacima o zaštiti od oštećenja.



Znakovi upozorenja s informacijama za bolje postupanje s uređajem.

## Opće sigurnosne upute

- Ovaj uređaj nije predviđen za uporabu od strane osoba (uključujući djecu) s ograničenim fizičkim, senzoričkim ili duševnim sposobnostima ili nedostatkom iskustva i/ili nedostatkom znanja; osim ako su pod nadzorom neke osobe nadležne za njihovu sigurnost ili od nje dobivaju upute, kako se mora koristiti uređaj.
- Djecu se mora nadzirati, kako biste bili sigurni, da se ne igraju s uređajem.
- Osobe, koje nisu upoznate s Uputom za uporabu, ne smiju koristiti uređaj. Upravljanje uređajem nije dopušteno osobama ispod 16 godina.

## Rad s uređajem



Oprez: Ovako Vi izbjegavate nezgode i povrede:



Visokotlačni uređaji za čišćenje mogu biti opasni kod nestručne uporabe. Mlaz se ne smije usmjeriti na ljude, životinje, aktivnu električnu opremu ili na sam uređaj.

- Uređaj koristite samo u stojećem položaju i na ravnoj i stabilnoj podlozi.
- Mlaz nemojte usmjeriti na samoga

sebe ili druge osobe radi čišćenja odjeće ili obuće.

- Radi zaštite od prskanja vode ili zaprljanja nosite prikladnu zaštitnu odjeću i zaštitne naočale.
- Nemojte koristiti uređaj, ako se druge osobe nalaze u njegovom dometu, osim ako one nose zaštitnu odjeću.
- Izvršite pogodne mjere, kako biste udaljili djecu od uključenog uređaja.
- Nemojte koristiti uređaj u blizini zapaljivih tekućina ili plinova. Kod nepridržavanja postoji opasnost od požara ili eksplozije.
- Nemojte raspršivati zapaljive tekućine. Postoji opasnost od eksplozije.
- Ako dođete u dodir sa sredstvima za čišćenje, isperite s dosta čiste vode.
- Uređaj čuvajte na suhom mjestu izvan dometa djece.



Oprez! Ovako Vi izbjegavate oštećenja uređaja i oštećenja osoba koja eventualno rezultiraju iz toga:

- Nemojte raditi s oštećenim, nepotpunim uređajem ili uređajem pregrađenim bez suglasnosti proizvođača. Dajte da prije puštanja u pogon stručnjak ispita, postoje li neophodne električne zaštitne mjere.
- Nemojte puštati uređaj u pogon, ako su oštećeni odn. nezaptiveni vod za mrežni priključak, dovod vode ili drugi važni dijelovi kao visokotlačno crijevo ili pištolj za prskanje.
- Uređaj zaštitite od mraza i rada na suho.
- Visokotlačna crijeva, armature i spojnice su važni za sigurnost stroja. Koristite samo visokotlačna crijeva, armature i spojnice, koje je proizvođač preporučio.
- Koristite samo originalni pribor i ne provodite nikakve pregradnje uređaja.
- Otvaranje uređaja mora izvršiti samo ovlašteni električar. U slučaju popravka uvijek se obratite našem servisnom centru.

## Električna sigurnost:



Oprez: Ovako Vi izbjegavate nezgode i povrede uslijed električnog udara:

- Pri primjeni produžnog voda utikač i spojnica moraju biti nepromočivi.



Neprikladni produžni vodovi mogu biti opasni. Postoji opasnost od oštećenja osoba uslijed električnog udara.

- Zaštite električne utične spojeve od vlage.
- Kod opasnosti od poplave smjestite utične spojeve u područje koje je sigurno od poplave.
- Pazite na to, da se mrežni napon slaže s podacima na natpisu s tipom.
- Mrežni priključak mora izvršiti iskusni električar i ispuniti zahtjeve IEC 60364-1.
- Priključite uređaj samo na utičnicu s pravom za zaštitu od struje kvara (FI-predkič) s dimenzioniranjem struje kvara ne više od 30 mA; osigurač 13 ampera.
- Ako se ošteti priključni vod ovoga uređaja, moraju ga zamijeniti proizvođač ili njegova servisna služba ili neka osoba sa sličnom kvalifikacijom jednim posebnim priključnim vodom, kako bi se izbjegla ugrožavanja.
- Nemojte koristiti kabel za izvlačenje utikača iz utičnice. Zaštite kabel od vrućine, ulja i oštih rubova.
- Uređaj nemojte nositi ili pričvrstiti za kabel.
- Koristite samo produžne kablove, koji su zaštićeni od prskanja vode i određeni za uporabu na otvorenom. Prije uporabe uvijek sasvim odmotajte kabelski bubanj. Provjerite, ima li oštećenja na kabelu.
- Prije svih radova na uređaju, u radnim pauzama i kod neuporabe izvucite mrežni utikač iz utičnice.

- Vodovi mrežnog priključka ne smiju imati manji poprečni presjek od  $2 \times 2,5 \text{ mm}^2$ .
- Radi zaštite od električnog udara nosite čvrstu obuću.
- Radi zaštite od električnog udara radite uređajem isključivo u uspravnom, stojećem položaju.

## Puštanje u pogon



Prema važećim propisima se visokotlačni uređaj za čišćenje nikada ne smije pogoniti bez odvajачa sustava na mreži pitke vode. Mora se koristiti prikladan odvajач sustava prema EN 12729 tip BA.

Voda, koja je protekla kroz odvajач sustava, klasificira se kao neprikladna za piće. Sustavni odvajач može se kupiti u specijaliziranoj trgovini.

- Koristite uobičajeno vrtno crijevo za dotok vode i pazite na dovoljnu duljinu.
- Uređaj koristite na kućnom priključku vode ili izvoru vode s najmanje 450 l/h transportne snage.

## Postavljanje

1. Stavite ručku za nošenje (2a) u četvrtaste cijevi postolja za nošenje. Ručka za nošenje (2a) čujno uklopi. Fiksirajte ručku za nošenje (2a) pomoću oba priložena vijka (2b) s ledne strane.
2. Navucite kuku za kabel (5) i držač pištolja za prskanje (11) na vođice na kućištu uređaja.
3. Uvijte visokotlačni priključak na strani pištolja (12) s pištoljem za prskanje (1). Pri tome koristite priloženi vilasti ključ (22).
4. Najprije priključite dovodno crijevo na opskrbu vodom i pustite da voda na drugom kraju dovodnog crijeva curi bez mjehurića radi odzračivanja dovodnog crijeva. Zatvorite slavinu.
5. Spojite dovodno crijevo pomoću brzog

- priključka za adapter za vrtno crijevo (13) s priključkom vode (9) na uređaju. Uvijek koristite sitasti umetak (8) i prema potrebi ga očistite.
6. Spojite mlaznu cijev s visokotlačnom mlaznicom (17) umetanjem i uvijanjem ili po izboru mlaznu cijev s mlaznicom s ravnim mlazom (18) ili rotirajuću četku (19) s pištoljem za prskanje (1) (pričvršćenje bajonet).
  7. Zamjena neke mlazne cijevi (17/18) ili rotirajuće četke (19) se vrši utiskivanjem i okretanjem u suprotnom smjeru.

## Mrežni priključak

Na visokotlačnom uređaju za čišćenje, koji ste Vi kupili, već postoji mrežni utikač. Uređaj je predviđen za priključak na utičnicu sa zaštitnim kontaktom sa zaštitnim uređajem struje kvara (FI-sklopkom) s 230 V ~ 50Hz.

 Uređaj stavite u pogon tek poslije pridržavanja svih prethodnih točaka.

1. Provjerite, da je visokotlačni uređaj za čišćenje isključen na uključivaču/isključivaču (10).
2. Utaknite mrežni utikač u utičnicu.

## Pogon

 **Obratite pozornost na snagu povratnog udara vodenog mlaza koji izlazi. Pobrinite se za sigurno stajalište i dobro i čvrsto držite pištolj za prskanje. Inače Vi možete povrijediti sebe ili druge osobe.**

 Nemojte vršiti pogon visokotlačnog uređaja za čišćenje sa zatvorenom slavinom za vodu. Rad na suho dovodi do oštećenja uređaja.

1. Potpuno otvorite slavinu za vodu.
2. Uključite visokotlačni uređaj za čišćenje

na uključivaču/isključivaču (10). Uvijek uključite visokotlačni uređaj za čišćenje tek onda, kad ste priključili sve dovode vode i kad su nepropusni.

Motor se uključuje, dok se ne stvori neophodni tlak. Poslije stvaranja tlaka motor se isključuje.

3. Pritisnite ručku za uključenje pištolja za prskanje (1). Mlaznica radi s tlakom i motor se opet uključuje. Otpuštanje ručke za uključenje aktivira isključenje uređaja. Visoki tlak u sustavu se zadržava.

- Mlazna cijev s visokotlačnom mlaznicom (17) je sa svojim rotirajućim vodenim mlazom naročito prikladna za rad s malom potrošnjom vode.
- Mlazna cijev s mlaznicom s ravnim mlazom (18) je sa svojim ravnim mlazom naročito prikladna za čišćenja površina. Okretanjem vrha mlaznice ulijevo Vi možete smanjiti širinu mlaza. Okretanjem vrha mlaznice udesno Vi možete povećati širinu mlaza.



**Kod nezaptivenosti u vodovodnom sustavu odmah isključite uređaj na uključivaču/isključivaču (10) i na vodu za mrežni priključak (6) odvojite uređaj od mreže. Opasnost od udara struje! Ponovno počnite s uspostavljanjem vodovodnih priključaka (v. "Puštanje u pogon / Postavljanje" od točke 4.).**

**Ako se zrak još nalazi u uređaju, postupite kako slijedi:**

### Odzračivanje dovodnog crijeva:

1. Najprije odzračite dovodno crijevo. Odstranite brzi priključak za adapter za vrtno crijevo (13) na priključku vode (9) i otvorite slavinu, dok voda ne curi bez mjehurića.

2. Zatvorite slavinu.
3. Spojite dovodno crijevo pomoću brzog priključka za adapter za vrtno crijevo (13) s priključkom vode (9) na uređaju.
4. Potpuno otvorite slavinu.

**Odzračivanje uređaja:**

5. Uključujte uključivač/isključivač (10), dok se ne stvori tlak.
6. Isključite uključivač/isključivač (10).
7. Pritisćite ručicu za uključenje pištolja za prskanje (1), dok se ne stvori tlak.
8. Molimo ponovite postupak 5. do 7. nekoliko puta, dok iz uređaja ne iziđe zrak.

**Visokotlačni / niskotlačni pogon**

Mlazna cijev s mlaznicom s ravnim mlazom (18) je izvedena po izboru za pogon s visokim tlakom i niskim tlakom.

U standardnom podešenju ta podesiva mlaznica s ravnim mlazom radi s visokim tlakom. Vi možete vrh mlaznice povući prema naprijed i tako promijeniti na niskotlačni pogon.

U ovom načinu rada (niski tlak) se automatski usisava iz ugrađenog spremnika sredstva za čišćenje (v. „Primjena sredstva za čišćenje“).

Promjena na visokotlačni način rada se vrši uvlačenjem vrha mlaznice.



- Vi možete polugu za uključenje (24) na pištolju za prskanje (1) po izboru blokirati ili deblokirati pritiskanjem gumba za blokiranje (23).

**Blokiranjem poluge za uključenje Vi sprječavate nenamjeravani start uređaja.**



blokirano

otvoreno

**Prekid pogona**

- Otpustite ručicu pištolja za prskanje (1).
- Kod duljih stanki pri radu isključite uključivač/isključivač (10).



**Ukoliko uređaj padne, odmah ga isključite na uključivaču/isključivaču (10) i na vodu za mrežni priključak (6) odvojite uređaj od mreže. Opasnost od udara struje! Tek sada opet podignite uređaj u uspravan, stojeći položaj. Radi Vaše vlastite sigurnosti sačekajte ca. pet minuta, prije nego što ponovno uspostavite električni priključak.**

**Završetak pogona**

1. Poslije radova sa sredstvima za čišćenje isperite sustav čistom vodom.
2. Otpustite ručicu (24) pištolja za prskanje (1).
3. Isključite visokotlačni uređaj za čišćenje na uključivaču/isključivaču (10).
4. Zatvorite slavinu za vodu. Izvucite mrežni utikač.
5. Odvojite visokotlačni uređaj za čišćenje od opskrbe vodom.
6. Povucite ručicu (24) pištolja za prskanje (1), da biste smanjili postojeći tlak u sustavu.

**Primjena sredstava za čišćenje**

Ovaj uređaj je proizveden za uporabu s neutralnim sredstvom za čišćenje na bazi biološki razgradivih anionskih tenzida. Primjena drugih sredstava za čišćenje ili kemijskih tvari može ugroziti sigurnost uređaja i dovesti do oštećenja. Takva oštećenja na uređaju ne podliježu garanciji.

**Punjenje/pražnjenje sredstva za čišćenje:**

- Za primjenu sredstva za čišćenje se to

sredstvo za čišćenje mora nalaziti u spremniku za sredstvo za čišćenje (15).

- Za skidanje spremnika za sredstvo za čišćenje (15) uhvatite spremnik bočno i povucite ga prema gore. Sada Vi možete izvaditi spremnik za sredstvo za čišćenje iz njegove donje i bočne vođice iz visokotlačnog uređaja za čišćenje. Pri tome skinite na otvoru spremnika za sredstvo za čišćenje (14) usisno crijevo sa kapom zatvarača. Oni ostaju na visokotlačnom uređaju za čišćenje.
- Kako biste ponovno umetnuli spremnik za sredstvo za čišćenje, postupajte obrnutim redoslijedom.

#### Radne upute:

- Koristite mlaznu cijev s mlaznicom s ravnim mlazom (18) u niskotlačnom pogonu i sredstvo za čišćenje se automatski usisava.
- Rotirajuća četka (19) načelno radi u niskotlačnom pogonu i tako uvijek usisava sredstvo za čišćenje.
- Ako želite rotirajuću četku (19) koristiti bez sredstva za čišćenje, morate skinuti spremnik za sredstvo za čišćenje (15).

## Čišćenje i Održavanje



Prije svih radova na uređaju izvucite mrežni utikač. Tu spada i priključivanje na dovod vode ili pokušaj odstranjivanja nezaptivenosti. Od pokretnih dijelova postoji opasnost od strujnog udara ili opasnost od povrede.

### Čišćenje



**Uređaj nemojte prskati vodom i nemojte ga čistiti pod tekućom vodom. Postoji opasnost od strujnog udara i uređaj bi se mogao oštetiti.**

**Uređaj uvijek održavajte čistim. Nemojte koristiti nikakva sredstva**

### za čišćenje odn. otapala.

- Proreze za provjetravanje održavajte čistim i slobodnim.
- Uređaj očistite mekanom četkom ili malo navlaženom krpom.
- Ukoliko je začepljena neka od mlaznica na mlaznoj cijevi (17/18), Vi možete iglom za čišćenje mlaznice (20) odstraniti strano tijelo u mlaznici.

### Održavanje

Visokotlačni uređaj za čišćenje nema održavanja.



**Dajte da radove, koji nisu opisani u ovoj Uputi, provede naš servisni centar. Koristite samo originalne dijelove.**

### Pohranjivanje

- Iz visokotlačnog uređaja za čišćenje potpuno ispraznite vodu. Odvojite uređaj od opskrbe vodom. Uključite visokotlačni uređaj za čišćenje na uključivaču/isključivaču (10) maksimalno 1 minutu, dok voda više ne curi na visokotlačnom priključku pištolj za prskanje (1). Isključite uređaj.
- Visokotlačni uređaj za čišćenje i pribor čuvajte u prostoriji koja je sigurna od smrzavanja.

### Uklanjanje/zaštita okoliša

Uređaj, pribor i pakiranje uklonite recikliranjem uz zaštitu okoliša.



Uređaji ne spadaju u kućno smeće.

Predajte uređaj na sabirnom mjestu za reciklažu. Korišteni plastični i metalni dijelovi mogu se odvojiti prema vrstama i tako podvrgnuti recikliranju. U vezi s tim raspitajte se u našem servisnom centru.

## Traženje grešaka

Problem	Mogući uzrok	Uklanjanje greške
Uređaj ne radi	Uključivač/ isključivač (10) je isključen	Ispitajte položaj uključivača/ isključivača (10)
	Oštećen vod mrežnog priključka (6)	Kontrolirajte, ima li oštećenja na vodu mrežnog priključka (6). Prema potrebi dajte da električar zamijeni vod mrežnog priključka (6).
	Pogrešna opskrba naponom	Kontrolirajte, slaže li se električno postrojenje s podacima na natpisu s tipom.
Uređaj nema tlaka	Zračne pore u visokotlačnom uređaju za čišćenje	Priključite uređaj s pištoljem za prskanje i bez mlaznice, dok ne curi voda bez mjehurića
	Opadanje tlaka u vodu	Kontrolirajte opskrbu vodom
Jaka kolebanja tlaka	Visokotlačna mlaznica (17) zaprljana	Vodom isperite visokotlačnu mlaznicu (17). Prema potrebi iglom očistite otvor mlaznice.
Nezaptivena mjesta u sustavu vode	Priključci nisu pravilno montirani	Isključite uređaj i odvojite ga od mreže. Ponovno priključite uređaj na vodovod (v. „Puštanje u pogon-postavljanje“)
	Priključak vode (9) nije nepropustan	Isključite uređaj i odvojite ga od mreže. Zamijenite priključak vode (9) uklj. brtveni prsten (v. „Rezervni dijelovi“)

## Rezervni dijelovi

Za dokupljivanje rezervnih dijelova koristite navedenu servisnu adresu i broj telefaksa. Molimo da kod Vaše narudžbe navedete tip stroja i broj atrikla rezervnoga dijela.

<b>A</b>	<b>Poz.</b>	<b>Oznaka.....</b>	<b>Br. artikla</b>
	1	Pištolj za prskanje.....	91097399
	3	Visokotlačno crijevo .....	91097400
	13	Brzi priključak za opskrbu vodom .....	91097401
	17	Mlazna cijev s visokotlačnom mlaznicom .....	91097403
	18	Mlazna cijev s mlaznicom s ravnim mlazom .....	91097404
	19	Rotirajuća četka.....	91097405
	9	Priključak vode sa sitastim umetkom.....	91097408

## Garancija

Poštovani kupci,

Vi dobivate na ovaj uređaj garanciju od 3 godine od datuma kupnje.

U slučaju nedostataka ovoga proizvoda, Vama pripadaju zakonska prava prema prodavaču proizvoda. Ova zakonska prava ne ograničavaju se našom dolje navedenom garancijom.

### Garancijski uvjeti

Garancijski rok počinje s datumom kupnje. Molimo, dobro čuvajte originalni blagajnički račun. Ovaj dokument potreban je kao dokaz kupnje.

Ukoliko u roku od tri godine od datuma kupnje ovoga proizvoda nastane neka greška materijala ili proizvodnje, mi taj proizvod za Vas besplatno – prema našem izboru – popravimo ili zamijenimo. Preduvjet za ovu garancijsku uslugu je, da se u roku od tri godine priloži taj pokvareni uređaj i dokaz o kupnji (blagajnički račun) te u pisanom obliku kratko opiše, u čemu se sastoji nedostatak i kada je nastao.

Ako je kvar pokriven našom garancijom, Vi dobivate natrag popravljeni ili novi proizvod. S popravkom ili zamjenom proizvoda ne započinje novi garancijski period.

### Garancijski period i zakonska prava na nedostatak

Garancijski period se ne produžava jamstvom. To vrijedi i za zamijenjene i popravljene dijelove. Oštećenja i nedostaci koji eventualno postoje već pri kupnji, moraju se prijaviti odmah nakon raspakiranja. Popravci koji nastanu poslije isteka garancijskog perioda podliježu plaćanju.

### Opseg garancije

Uređaj je brižljivo proizveden prema strogim smjernicama o kvaliteti i prije isporuke je savjesno ispitan.

Garancijska usluga vrijedi za greške materijala ili proizvodnje. Ova garancija ne obuhvaća dijelove proizvoda, koji su izloženi normalnom trošenju i stoga se mogu smatrati potrošnim dijelovima (npr. letvica s noževima, ekcentar i ugljene četkice) ili oštećenja lomljivih dijelova (npr. sklopke, punjači).

Ova garancija otpada, ako je proizvod oštećen, nestručno korišten ili nije održavan. Za stručno korištenje proizvoda morate se točno pridržavati svih uputa navedenih u Uputi za upravljanje. Morate obvezno izbjegavati svrhe primjene i postupke, koje Vam u Uputi za upravljanje ne savjetujemo ili na koje upozoravamo.

Proizvod je namijenjen samo za privatnu, a ne za industrijsku uporabu. Garancija se gubi kod zloporabe i nestručnog upravljanja, primjene sile i kod zahvata, koje ne poduzme naša autorizirana servisna poslovnica.

### Obavljanje garancijskog slučaja

Kako bismo omogućili brzu obradu Vaših želja, molimo pridržavajte se sljedećih uputa:

- Molimo, za sve upite pripremite blagajnički račun i broj artikla (npr. IAN 12345) kao dokaz kupnje.
- Broj artikla molimo pronađite na pločici s natpisom, gravuri, na naslovnom listu Vaše Upute (dolje lijevo) ili kao naljepnicu na poleđini ili donjoj strani.
- Ukoliko nastanu greške funkcije ili ostali nedostaci, najprije kontaktirajte dolje navedeno Servisno odjeljenje **telefonom** ili putem **e-maila**. Zatim ćete dobiti daljnje informacije o obavljanju Vaše reklamacije.
- Proizvod koji smatrate pokvarenim, Vi možete poslije dogovora s našom Službom za kupce, uz prilaganje dokaza o kupnji (blagajnički račun) i podatka, u čemu se sastoji nedostatak i kada je nastao, bez plaćanja poštarine poslati



na Vama priopćenu adresu servisa. Kako bismo izbjegli probleme oko prijema i dodatne troškove, obvezno koristite samo onu adresu, koja Vam je priopćena. Provjerite, da se otprema ne izvrši bez plaćenih troškova dostave, kao glomazna roba, express ili drugi specijalni teret. Molimo, pošaljite uređaj uključujući sve dijelove pribora isporučene pri kupnji i pobrinite se za dovoljnu sigurnost transportnog pakiranja.

## Servis za popravke

Vi možete dati nalog za izvršenje popravka, koji ne podliježu garanciji u našoj Servisnoj poslovnici uz obračun usluge. Ona će Vam rado izraditi Predračun troškova.

Mi možemo obraditi samo one uređaje, koji se pošalju dovoljno zapakirani i frankirani.

**Pozor:** Molimo, pošaljite u našu Servisnu poslovnicu svoj uređaj očišćen i s napomenom na vrstu kvara.

Uređaji poslani bez plaćenih troškova dostave – kao glomazna roba, express ili s drugim specijalnim teretom – neće biti primljeni.

Mi vršimo besplatno uklanjanje Vaših pokvarenih uređaja.



## Service-Center

### Servis Hrvatska

Tel.: 0800 777 999

E-Mail: grizzly@lidl.hr

IAN 78960



## Servisna poslovnica

Molimo obratite pozornost, da sljedeća adresa nije adresa servisa. Najprije kontaktirajte gore navedeni Servisni centar.

### Microtec sistemi d.o.o.

Koprivnicka 27°

10000 Zagreb

## Cuprins

<b>Introducere .....</b>	<b>26</b>
<b>Domeniul de aplicare .....</b>	<b>26</b>
<b>Descriere generală .....</b>	<b>27</b>
Inventar de livrare .....	27
Descrierea modului de funcționare ...	27
Privire de ansamblu .....	27
<b>Date tehnice .....</b>	<b>28</b>
<b>Instrucțiuni de siguranță .....</b>	<b>28</b>
Simboluri înscrise pe aparat .....	28
Simboluri folosite .....	29
Instrucțiuni generale de siguranță .....	29
<b>Punere în funcțiune .....</b>	<b>30</b>
Amplasare .....	31
Conectarea la rețea .....	31
Operare .....	31
Operare cu înaltă presiune /	
cu joasă presiune .....	32
Înteruperea operării .....	32
Finalizarea operării .....	33
Utilizarea de detergenți .....	33
<b>Curățire și mentenanță .....</b>	<b>33</b>
Curățare .....	34
Mentenanță .....	34
<b>Depozitare .....</b>	<b>34</b>
<b>Reciclare/Protecția mediului</b>	
<b>înconjurător .....</b>	<b>34</b>
<b>Identificare defecțiuni .....</b>	<b>35</b>
<b>Piese de schimb .....</b>	<b>35</b>
<b>Garanție .....</b>	<b>36</b>
<b>Reparații-Service .....</b>	<b>37</b>
<b>Service-Center .....</b>	<b>37</b>
<b>Departament Service .....</b>	<b>37</b>
<b>Traducerea Declarației Originale</b>	
<b>de Conformitate CE .....</b>	<b>63</b>

## Introducere



Felicitări pentru achiziția noului Dvs. aparat.

Ați luat o decizie înțeleaptă și ați achiziționat un produs valoros. Manualul de operare este parte integrantă a acestui produs. Acesta include instrucțiuni importante despre siguranță, utilizare și eliminare.

Înainte de a începe să folosiți aparatul, familiarizați-vă cu toate instrucțiunile privind operarea și siguranța. Folosiți aparatul doar în conformitate cu manualul de operare și doar în scopurile recomandate.

Mențineți manualul în condiții corespunzătoare și, odată cu transmiterea instalației către terți, predați și toată documentația aferentă.

## Domeniul de aplicare

Acest aparat de curățire cu înaltă presiune trebuie folosit doar pentru uz casnic:

- Acest aparat nu este destinat pentru uzul industrial. În cazul utilizării în scop industrial, dreptul la garanție este anulat.
- Pentru curățarea de mașini, automobile, clădiri, instrumente, fațade, terase, scule pentru grădinarit șamd, cu jet de apă cu înaltă presiune.
- Cu accesorii și piese de schimb originale.
- Respectând instrucțiunile fabricantului referitoare la obiectele ce pot fi curățate.
- Peria rotativă nu este în general adecvată pentru suprafețele sensibile și lăcuite (de ex. lac pentru mașini).

## Descriere generală

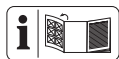

Imaginea celei mai importante piese funcționale a pompei se află pe partea rabatabilă.

## Inventar de livrare

Despachetați aparatul și verificați inventarul de livrare:

- Aparat de curățire cu înaltă presiune cu conexiune la rețea
- Furtun de înaltă presiune, pe tambur
- Mâner + 2 șuruburi
- Cârlig pentru cablul de alimentare
- Suport pentru pulverizator
- Conector rapid pentru adaptorul furtunului de grădină
- Pulverizator
- Cheie tip furcă
- Tub cu duză de înaltă presiune (freză turbo mizerie)
- Tub cu duză pentru ventilator (duză standard vario)
- Perie rotativă
- Ac de curățare a duzei
- 0,5 l de detergent
- Instrucțiuni de utilizare

Reciclați în mod corespunzător ambalajul.

## Descrierea modului de funcționare

Aparatul de curățire cu înaltă presiune funcționează cu ajutorul unui jet de apă, în regim cu presiune redusă sau crescută.

Dacă este nevoie, suplimentați cantitatea de detergent.

Funcția unității de comandă se regăsește în descrierile următoare.

Respectați instrucțiunile de siguranță.

## Privire de ansamblu

- |          |  |
|----------|--|
| <b>A</b> | 1 Pulverizator   |
|          | 2a Mâner   |
|          | 2b 2 șuruburi  |
|          | 3 Furtun de înaltă presiune pe tambur                          |
|          | 4 Manivelă pentru tamburul furtunului                          |
|          | 5 Cârlig pentru cablul de alimentare                           |
|          | 6 Conexiune la rețea   |
|          | 7 Roți   |
|          | 8 Cartuș de filtrare   |
|          | 9 Alimentare cu apă  |
|          | 10 Conector/Deconector   |
|          | 11 Suport pentru pulverizator                                  |
|          | 12 Racord de înaltă presiune pe partea pulverizatorului        |
|          | 13 Conector rapid pentru adaptorul furtunului de grădină       |
|          | 14 Orificiu în recipientul pentru detergent                    |
|          | 15 Recipient pentru detergent                                  |
|          | 16 Suport accesorii  |
|          | 17 Tub cu duză de înaltă presiune (freză turbo pentru mizerie) |
|          | 18 Tub cu duză pentru ventilator (duză standard vario)         |
|          | 19 Perie rotativă  |
|          | 20 Ac de curățare a duzei                                      |
|          | 21 Detergent   |
|          | 22 Cheie tip furcă   |
| <b>B</b> | 23 Buton de blocare  |
|          | 24 Pârghie de conectare  |

## Date tehnice

### Aparat ..... PHD 150 B2

Racord nominal la rețea ..... 230V~, 50 Hz

Putere consumată ..... 2100 W

Lungime cablu de rețea ..... 5 m

Greutate ..... 10,8 kg

Clasă de izolare .....  II

Tip de izolare ..... IPX5

Presiune nominală/Presiune de lucru

(p) ..... 11 MPa

Presiunea maximă admisă a apei

(p max) ..... 15 MPa

Presiune maximă de admisie

(p in max) ..... 0,8 MPa

Temperatură maximă de admisie

(T in max) ..... 40°C

Debit, apă (Q) ..... 5,5 l/min

Debit maximă, apă (Q max) ..... 7,5 l/min

Nivel de presiune acustică

( $L_{pA}$ ) ..... 78,2 dB (A);  $K_{pA} = 3,0$  dB (A)

Nivel de intensitate acustică ( $L_{WA}$ )

măsurat ..... 91,7 dB (A);  $K_{WA} = 3,0$  dB (A)

garantat ..... 98,0 dB (A)

Vibrație (an) ..... 0,496 m/s<sup>2</sup>; K = 1,5 m/s<sup>2</sup>

Aparatul este prevăzut pentru a fi utilizat doar în rețele care au o sarcină admisibilă a curentului continuu 0,277 Ohm, și care sunt alimentate, printr-o rețea de distribuție, cu o tensiune nominală.

Dacă este necesar, comunicați companiei furnizoare de electricitate faptul că sarcina admisibilă a curentului continuu specifică rețelei, la punctul de racordare, este suficientă pentru conectarea aparatului.

În timpul procesului de dezvoltare, pot fi aduse modificări tehnice și optice, fără informare prealabilă. Astfel, măsurile, indiciile și instrucțiunile stipulate în acest manual de operare nu oferă nicio garanție. De aceea, solicitările legale emise pe baza acestui manual de operare nu pot fi făcute valabile.

## Instrucțiuni de siguranță

Acest capitol prezintă principalele instrucțiuni de siguranță ce trebuie respectate atunci când se lucrează cu aparatul de curățire cu înaltă presiune.

### Simboluri înscrise pe aparat



Atenție!



Înainte de a începe să operați pompa, citiți cu atenție despre toate elementele de operare, dar mai ales despre funcțiile și mecanismele de acționare ale acestora. Dacă este cazul, consultați un specialist. Citiți și respectați manualul de operare aferent aparatului!



Atenție! În cazul în care cablul de rețea este deteriorat sau secționat, trageți imediat ștecherul din priză. Scoateți ștecherul din priză atunci când conectați aparatul la sursa de alimentare cu apă sau când încercați să îndepărtați sursele de neatenționate.



Aparatul nu este adecvat pentru a conecta la instalația de alimentare cu apă potabilă.



Clasă de izolare



Dispozitivele electrice nu trebuie aruncate în deșeurile casnice.



Aparatele de curățire cu înaltă presiune pot reprezenta o sursă de risc dacă nu sunt utilizate corespunzător. Jetul de apă nu trebuie îndreptat asupra persoanelor, animalelor, echipamentelor electrice active sau chiar asupra aparatului de curățire cu înaltă presiune.



Operați aparatul numai în poziție verticală, nicio dată orizontală.

## Simboluri folosite



**Semnale de pericol (în locul semnului de exclamare, care poate exprima pericolul) cu date referitoare la prevenirea vătămărilor corporale sau daunelor materiale.**



Semnale de interdicție (în locul semnului de exclamare care poate exprima interdicția) cu date referitoare la prevenirea daunelor materiale.



Indicatoare cu date despre operarea facilă a aparatului..

## Instrucțiuni generale de siguranță

- Acest aparat nu a fost desemnat pentru a fi folosit de persoane (inclusiv copii) cu abilități fizice, senzoriale sau spirituale limitate sau fără experiență și/sau cunoștințe; dacă aceste situații survin, respectivele persoane trebuie fie supravegheate de o persoană responsabilă pentru siguranța lor, fie instruite referitor la modul în care trebuie folosit aparatul.
- Copiii trebuie supravegheați, pentru a vă asigura că nu folosesc aparatul ca și obiect de joacă.
- Persoanele nefamiliarizate cu manualul de operare nu trebuie să lucreze cu aparatul. Operarea mașinii este interzisă persoanelor cu vârste sub 16 ani.

## Lucrul cu mașina



**Atenționare! Astfel evitați accidentele și vătămările corporale:**



Aparatele de curățire cu înaltă presiune pot reprezenta o sursă de risc dacă nu sunt utilizate corespunzător. Jetul de apă nu trebuie în-

dreptat asupra persoanelor, animalelor, echipamentelor electrice active sau chiar asupra aparatului de curățire cu înaltă presiune.

- Aparatul trebuie folosit numai în poziție verticală, pe o suprafață perfect plană și stabilă.
- Nu îndreptați jetul de apă asupra Dvs. sau altor persoane, pentru a curăța hainele sau încălțăminte.
- Pentru a vă proteja de apa sau murdăria proiectată în urma aparatului, purtați îmbrăcăminte și ochelari de protecție adecvați.
- Nu folosiți aparatul atunci când alte persoane se află în raza de acțiune a acestuia; dacă aceste situații survin, persoanele respective trebuie să poarte îmbrăcăminte de protecție.
- Luați-vă măsurile necesare pentru a menține copiii departe de aparatul aflat în mișcare.
- Nu folosiți aparatul în apropierea unor fluide sau gaze inflamabile. Nerespectarea acestei instrucțiuni duce la risc la explozie sau incendiu.
- Nu pulverizați niciodată lichide inflamabile. Există pericolul de explozie
- Dacă veniți în contact cu detergentul, clătiți din abundență cu apă curată.
- Mențineți aparatul într-un loc uscat și în afara accesului copiilor.



**Atenționare! Astfel evitați deteriorarea aparatului și eventualele accidente astfel generate:**

- Nu folosiți un aparat deteriorat, incomplet sau care a fost adaptat fără acordul fabricantului. Înainte de punerea în funcțiune a aparatului, angajați un specialist pentru a verifica dacă s-au luat măsurile de protecție electrică necesare.
- Nu puneți aparatul în funcțiune dacă conexiunea la rețea, orificiul pentru admisia apei sau alte componente

importante, cum ar fi furtunul de înaltă presiune sau pulverizatoarele, sunt deteriorate respectiv neetanșe.

- Protejați aparatul împotriva înghețului sau „uscării”.
- Furtunurile de înaltă presiune, armăturile și garniturile sunt importante pentru siguranța aparatului. Folosiți doar furtunuri de înaltă presiune, armături și garnituri recomandate de fabricant.
- Pentru a asigura securitatea mașinii, folosiți doar piese de schimb originale sau aprobate de fabricant.
- Operațiunile de deschidere a aparatului trebuie realizate numai de către un electrician autorizat. În cazul în care sunt necesare reparații, adresați-vă centrului nostru de service.

## Siguranță electrică:



### Atenționare: Astfel evitați accidente și vătămări corporale cauzate de șocul electric:

- Dacă utilizați un cablu prelungitor, ștecherul și conectorul trebuie să fie impermeabile.



Cablurile prelungitoare necorespunzătoare pot fi periculoase. Apare astfel riscul de vătămare corporală prin electrocutare.

- Protejați conectoarele electrice împotriva umidității.
- În cazul în care apare pericolul de inundare, depozitați conectoarele electrice într-un spațiu asigurat contra inundațiilor.
- Aveți grijă ca tensiunea de rețea să corespundă datelor de pe plăcuța de fabricație.
- Racordul la rețea trebuie realizat doar de electricieni experimentați, și trebuie să respecte prevederile IEC 60364-1.
- În cazul operării în condiții de umiditate, conectați aparatul doar la o priză cu

disjunctor de siguranță (SI) cu un curent de acționare nominal de maxim 30 mA.

- Înaintea fiecărei puneri în funcțiune, verificați dacă aparatul, cablul și ștecherul prezintă daune.
  - În cazul în care cablul conector al acestui aparat este deteriorat, trebuie să contactați fabricantul, centrul de service sau o persoană autorizată în acest sens, pentru a evita orice pericol.
  - Nu vă folosiți de cablu pentru a scoate ștecherul din priză. Protejați cablul împotriva căldurii, uleiului și marginilor ascuțite.
  - Nu folosiți cablul pentru a aduce aparatul mai aproape de Dvs sau pentru a-l fixa în poziție.
  - Folosiți doar prelungitoare cu protecție împotriva apei ce stropeste și care sunt adecvate pentru lucrul în aer liber. Înainte de utilizare, derulați complet un tambur de cabluri. Verificați astfel încât cablul să nu fie deteriorat.
- Înaintea efectuării oricărui lucrări asupra aparatului, în timpul pauzelor de lucru și atunci când aparatul nu este folosit, cablul de rețea trebuie să fie deconectat.
- Cablurile de alimentare la rețea trebuie să aibă diametrul minim de  $2 \times 2,5 \text{ mm}^2$ .
  - Pentru a vă proteja împotriva șocului electric, purtați bocanci cu tălpi anti-derapante.
  - Pentru a vă proteja împotriva șocului electric, operați dispozitivul exclusiv în poziție dreaptă, verticală.

## Punere în funcțiune



Conform prevederilor valabile în domeniu, aparatul de curățire cu înaltă presiune nu trebuie să fie conectat niciodată la rețeaua de alimentare cu apă potabilă, fără separatorul de sistem. Trebuie folosit un separator de sistem adecvat, conform EN 12729 Tip BA.

Apa care a trecut printr-un separator de sistem nu este calificată drept potabilă.

Separatoarele de sistem sunt disponibile în magazinele de specialitate.

- Folosiți un furtun de grădină din comerț pentru admisia apei și aveți grijă ca acesta să fie suficient de lung.
- Conectați dispozitivul la o rețea domestică de alimentare cu apă sau la o sursă de apă cu un debit minim de 450 l/h.

## Amplasare

1. Împingeți mânerul (2a) în tuburile rectangulare ale structurii portante. Mânerul (2a) se va cupla în poziție cu un declic. Cu ajutorul celor două șuruburi (2b) în cruce furnizate, înșurubați strâns mânerul (2a) de partea posterioară a aparatului.
2. Împingeți cârligul pentru cablu (5) și suportul pentru pulverizator (11) pe ghidajele de pe carcasa aparatului.
3. Înșurubați racordul de înaltă presiune de pe partea pistolului (12) cu pulverizatorul (1). În acest scop, utilizați cheia tip furcă anexată.
4. Racordați mai întâi tubul de evacuare la conducta de alimentare cu apă și, pe celălalt capăt al tubului de evacuare, lăsați apa să curgă până când nu mai are bule, pentru a aerisi tubul de aspirare. Închideți robinetul de apă.
5. Cu ajutorul conectorului rapid pentru adaptorul furtunului de grădină (13), racordați tubul de evacuare la sursa de alimentare cu apă (9) de pe aparat. Folosiți mereu cartușul de filtrare (8) și curățați-l dacă este nevoie.
6. Prin inserare și rotire, conectați tubul cu duză de înaltă presiune (17), sau, la alegere, tubul cu duză pentru ventilator (18) sau peria rotativă (19), cu pulverizatorul (1) (închidere tip baionetă).
7. Înlocuirea unui tub (17/18) sau a periei

rotative (19) se face prin inserare și rotire în direcția opusă.

## Conectarea la rețea

Aparatul de curățire cu înaltă presiune achiziționat este deja prevăzut cu un ștecher cu împământare. Aparatul trebuie să fie conectat doar la o priză cu împământare cu disjuncteur de siguranță (conector FI), de 230 V ~ 50Hz.



Aparatul poate fi pus în funcțiune doar după implementarea operațiilor menționate anterior.

1. Asigurați-vă că aparatul de curățire cu înaltă presiune nu este conectat la conector/deconector (10).
2. Introduceți ștecherul de rețea în priză.

## Operare



**Țineți cont de forța de reacție a jetului de apă emis. Adoptați o poziție sigură și țineți ferm pulverizatorul (1). În caz contrar vă puteți răni, atât pe Dvs. cât și alte persoane.**



Atunci când operați mașina de curățire cu înaltă presiune, robinetul pentru apă trebuie să fie mereu deschis. Operarea „pe uscat” a mașinii duce la deteriorarea acesteia.

1. Deschideți complet robinetul pentru apă
2. Conectați aparatul de curățire cu înaltă presiune la conector/deconector (10). Porniți întotdeauna aparatul de curățire cu înaltă presiune abia după ce ați racordat toate conductele de apă. Motorul stă pornit până când se formează presiunea dorită.
3. Apăsăți pârghia de conectare a pulverizatorului (1). Duza funcționează cu presiune, iar motorul este repornit.

Eliberarea unei pârghii de conectare acționează oprirea aparatului. Înalta presiune din sistem se menține.

- Tubul cu duză de înaltă presiune (17) este adecvat mai ales pentru operarea cu debit redus de apă.
- Tubul cu duză pentru ventilator (18) este adecvat mai ales pentru curățirea de suprafațe.

Prin rotirea către stânga a vârfului duzei puteți reduce lățimea jetului. Prin rotirea către dreapta a vârfului duzei puteți mări lățimea jetului.



**Dacă există indicii de neetanșeitate la sistemul de apă, opriți imediat aparatul cu ajutorul conectorului/deconectorului (10) și scoateți din priză cablul de conectare la rețea (6). Există pericol de electrocutare! Reîncepeți procedura de creare a surselor de alimentare cu apă (v. „Punere în funcțiune / Amplasare” de la punctul 4.).**

**Dacă încă mai există aer în interiorul dispozitivului, procedați astfel:**

**Aerisiți tubul de evacuare:**

1. Îndepărtați conectorul rapid pentru alimentarea cu apă (13) de pe sursa de alimentare cu apă (9) și deschideți robinetul de apă până când aceasta curge fără bule de aer.
2. Închideți robinetul de apă.
3. Cu ajutorul conectorului rapid pentru adaptorul furtunului de grădină (13), racordați tubul de evacuare la sursa de alimentare cu apă (9) de pe aparat.
4. Deschideți complet robinetul de apă.

**Aerisiți aparatul:**

5. Apăsăți pe conector/deconector (10) până se formează presiune în interiorul dispozitivului.

6. Apăsăți din nou pe conector/deconector (10) pentru a opri aparatul.
7. Apăsăți pârghia de conectare a pulverizatorului (1) până se formează presiune.
8. Repetați pașii 5. până la 7. de câteva ori, până nu mai există deloc aer în interiorul dispozitivului.

## Operare cu înaltă presiune/ cu joasă presiune

Tubul cu duză pentru ventilator (18) este setat din fabricație pentru operarea, la alegere, cu înaltă presiune sau cu presiune redusă.

În mod standard, duza pentru ventilator este setată să opereze la înaltă presiune. Pentru a lucra cu presiune redusă, împingeți vârful duzei înainte.

În acest mod de operare (cu presiune redusă) detergentul este automat absorbit din recipientul aferent (v. „Utilizarea de detergenți”).

Revenirea la modul de operare cu înaltă presiune se face prin aducerea vârfului duzei în poziția anterioară.



- Pârghia de conectare a pulverizatorului (1) se poate bloca sau debloca prin apăsarea butonului de blocare (23).

**Prin blocarea pârghiei de conectare evitați o pornire accidentală a aparatului.**



blocat

deschis

## Întreruperea operării

- Eliberați pârghia de conectare a pulverizatorului (1).



- În pauzele mai mari de lucru, deconectați aparatul de curățire cu înaltă presiune de la conector/deconector (10).



**Dacă aparatul se răstoarnă, opriți-l cu ajutorul conectorului/deconectorului (10) și scoateți din priză cablul de conectare la rețea (6). Există pericol de electrocutare! Aduceți din nou aparatul în poziție dreaptă, verticală. Pentru siguranța Dvs., așteptați cca. cinci minute înainte de a recrea racordul electric.**

## Finalizarea operării

1. După ce ați folosit detergentul, clătiți sistemul cu apă curată, pulverizând apă fără a folosi modul de operare cu joasă presiune.
2. Eliberați pârgăhia de conectare a pulverizatorului (1).
3. Deconectați aparatul de curățire cu înaltă presiune la conector/deconector (10). Trageți ștecherul de rețea.
4. Închideți robinetul pentru apă.
5. Deconectați aparatul de curățire cu înaltă presiune de la sursa de alimentare cu apă.
6. Trageți pârgăhia de conectare a pulverizatorului (1), pentru a forma presiunea necesară în sistem.

## Utilizarea de detergenți

Acest aparat a fost dezvoltat pentru a fi folosit împreună cu detergenți naturali pe bază de tenside anionice bio-degradabile. Utilizarea unui alt tip de detergent sau substanțe chimice poate afecta siguranța aparatului și duce la deteriorarea acestuia. Daunele la aparat astfel rezultate nu sunt acoperite de dreptul la garanție.

## Umpleți cu detergent/goliți detergentul:

- Pentru a putea utiliza detergenți, aceștia trebuie să se afle în recipientul aferent (15) al aparatului.
- Pentru a îndepărta recipientul pentru detergent (15) trageți recipientul pe laterală și împingeți-l în sus. Acum puteți scoate recipientul din ghidajele inferioare și laterale ale aparatului de curățire cu înaltă presiune. În același timp, îndepărtați și furtunul de absorbție cu capa de închidere, aflate la deschiderea (14) aparatului de curățire cu înaltă presiune. Acestea rămân pe aparatul de curățire cu înaltă presiune.
- Atunci când veți dori să reutilizați recipientul pentru detergent, urmați aceiași pași în ordine inversă.

## Instrucțiuni de lucru:

- Utilizați tubul cu duză pentru ventilator (18) în modul de operare cu joasă presiune, iar detergentul va fi automat absorbit.
- Peria rotativă (19) este acționată, de obicei, în modul de operare cu joasă presiune, astfel absorbind mereu detergentul.
- Dacă doriți să folosiți peria rotativă (19) fără detergenți, trebuie să îndepărtați recipientul pentru detergent (15).

## Curățire și mentenanță



Înainte efectuării oricăror lucrări asupra aparatului, deconectați mai întâi cablul de rețea. Printre acestea se numără și racordarea la sursa de alimentare cu apă sau încercarea de a îndepărta neatenșeițiile. Există pericolul unui șoc electric sau riscul de vătămare corporală cu piesele mobile.

## Curățare



**Nu pulverizați apă pe mașină și nu o curățați sub jet de apă. Există riscul de șoc electric, aparatul putând fi astfel deteriorat.**

**Este ideal să mențineți aparatul curat. Nu folosiți detergenți sau solvenți.**

- Orificiile de aerisire trebuie să fie mereu curate și să nu fie blocate.
- Curățați mașina cu o perie moale sau un prosop umed.
- Dacă una din duzele de pe tub (17/18) se blochează, puteți utiliza acul de curățire a duzei (20) pentru a elimina corpurile străine din interiorul acesteia.

## Mentenanță

Aparatul de curățire cu înaltă presiune nu necesită mentenanță.



**Pentru lucrările care nu sunt descrise în acest ghid, apălați la centrul nostru de service. Folosiți doar piese de schimb originale. Aceasta generează riscul de vătămare corporală.**

## Depozitare

- Goliți toată apa din interiorul aparatul de curățit cu înaltă tensiune.
- În acest scop, deconectați aparatul de la sursa de alimentare cu apă. Conectați-l la conector/deconector (10) pentru cel mult 1 minut, până când nu mai iese apă de la nivelul pulverizatorului (1) sau al accesoriilor ((17/18/19). Apoi deconectați aparatul.
- Aparatul și accesoriile aferente pot fi distruse de îngheț, dacă apa nu a fost

golită complet din aparat.

- Depozitați aparatul și accesoriile sale într-un spațiu ferit de îngheț.

## Reciclare/Protecția mediului înconjurător

Predați aparatul, accesoriile și ambalajul către o unitate de reciclare ecologică.



Aparatele nu trebuie aruncate în deșeurile casnice.

Predați aparatul către o unitate de reciclare. Componentele plastice și metalice folosite pot fi colectate separat, contribuind la eficientizarea procesului de reciclare. În acest sens, adresați-vă centrului nostru de service.

## Identificare defecțiuni

Problemă	Cauză posibilă	Eliminare eroare
Aparatul nu funcționează	Conector/Deconector (10) deconectat	Verificați poziția conectorului/deconectorului (10).
	Conexiune la rețea (6) deteriorată	Verificați dacă conexiunea la rețea (6) este deteriorată. Dacă este necesar, contactați un specialist pentru a înlocui conexiunea la rețea (6).
	Alimentare cu tensiune, defectuoasă	Verificați dacă instalația electrică respectă datele înscrise pe plăcuța de fabricație.
Aparatul nu are presiune	Admisie de aer în aparatul de curățire cu înaltă presiune	Conectați aparatul cu pulverizator și fără duze, până când iese apă fără bule.
	Cădere a presiunii din conductă	Verificați alimentarea cu apă.
Oscilații mari de presiune	Duza de înaltă presiune (17), murdară	Clățiți duza de înaltă presiune (17) cu apă. Dacă e nevoie, curățați orificiul duzei cu un ac.
Neetanșeități la sistemul de apă	Racordurile nu sunt corect realizate	Opriiți aparatul și scoateți-l din priză. Conectați din nou aparatul la conductele de apă (v. „Punere în funcțiune-amplasare”).
	Sursă de alimentare cu apă (9) neetanșă	Opriiți aparatul și scoateți-l din priză. Înlocuiți sursa de alimentare cu apă (9) incl. inelul de etanșeizare (v. „Piese de schimb”).

## Piese de schimb

Pentru înlocuirea pieselor de schimb, adresați-vă centrului de service, la adresa sau la numărul de fax furnizat. În momentul efectuării comenzii, furnizați informații privind tipul mașinii Dvs. și numărul de articol aferent piesei de schimb.

<b>A</b>	<b>Poz.</b>	<b>Descriere.....</b>	<b>Nr. articol</b>
	1	Pulverizator.....	91097399
	3	Furtun de înaltă presiune .....	91097400
	13	Conector rapid pentru alimentarea cu apă.....	91097401
	17	Tub cu duză de înaltă presiune.....	91097403
	18	Tub cu duză pentru ventilator .....	91097404
	19	Perie rotativă.....	91097405
	9	Alimentare cu apă cu cartuș de filtrare .....	91097408

## Garanție

Stimată clientă, stimate client,  
Pentru acest aparat veți primi 3 ani de garanție, de la data achiziției.

În cazul în care aparatul este deteriorat, aveți dreptul legal de a solicita compensarea prejudiciilor de către comerciantul produsului. Aceste drepturi legale nu sunt limitate de garanția oferită de noi și prezentată în cele ce urmează.

### Clauze de garanție

Termenul garanției începe de la data achiziționării aparatului. Vă rugăm să păstrați în condiții corespunzătoare bonul de casă original. Acest document este solicitat ca și dovadă a achiziției.

Dacă, pe parcursul a trei ani din momentul achiziției, apare vreo daună materială sau de fabricație, produsul va fi reparat sau înlocuit gratuit – la alegerea noastră. Serviciile prestate în perioada garanției presupun ca, în cadrul termenului-de-trei-ani, să fie prezentate aparatul defect și dovada achiziției (bonul de casă) și să se descrie pe scurt în ce constă și când a apărut dauna. Dacă defectul nu este acoperit de garanție, veți primi fie produsul reparat fie unul nou. Din momentul reparării sau înlocuirii produsului, dreptul la garanție este anulat.

### Perioada de garanție și dreptul la repararea prejudiciului

Perioada de garanție nu se prelungește după ce aceasta expiră. Acest lucru este valabil și pentru componentele înlocuite și reparate. Este recomandabil ca eventualele daune și lipsuri să fie comunicate imediat după achiziție. După expirarea garanției, reparațiile necesare sunt realizate contra-cost.

### Conținutul garanției

Aparatul este fabricat în conformitate cu standarde de calitate foarte înalte și este testat în detaliu înainte de livrare.

Dreptul la garanție este valabil pentru erorile materiale sau de fabricație. Această garanție nu acoperă componente ale produsului care sunt expuse unui grad normal de uzură și care, din acest motiv, pot fi considerate ca piese de schimb (de ex. filtrul sau accesoriile) și nici daunele produse asupra componentelor fragile (de ex. comutator, acumulatori sau fabricate din sticlă).

Această garanție este anulată dacă produsul a fost deteriorat, folosit necorespunzător sau dacă nu a fost supus lucrărilor de mentenanță. Pentru a garanta o utilizare corespunzătoare a produsului trebuie să respectați instrucțiunile din manualul de operare. Trebuie neapărat evitate acele domenii de aplicare și acțiuni care sunt contra-indicate sau asupra cărora avertizează manualul de utilizare.

Produsul trebuie să fie folosit doar pentru uz privat, nu industrial. Garanția este anulată în cazul unei manipulări abuzive sau necorespunzătoare, al folosirii forței și în cazul intervențiilor care nu au fost efectuate de departamentul nostru autorizat de service.

### Executarea garanției

Pentru a garanta o procesare rapidă a cazului Dvs., vă rugăm să respectați următoarele instrucțiuni:

- Păstrați bonul de casă și numărul articolului (de ex. IAN 12345) ca și dovadă a achiziției produsului.
- Numărul articolului este înscris pe plăcuța de fabricație, pe o gravură, pe pagina de titlu a manualului Dvs. (jos în stânga) sau lipit, ca și adeziv, pe partea posterioară sau inferioară a aparatului.
- Dacă apar erori funcționale sau alte lipsuri, contactați imediat, **telefonice** sau prin **e-mail**, departamentul de service menționat mai jos. Veți primi informații suplimentare referitoare la modalitatea de soluționare a reclamației Dvs.

- Produsul evaluat ca fiind defect, în urma consultării cu serviciul nostru de relații cu clienții, poate fi expediat gratuit către departamentul de service indicat de noi, odată cu dovada achiziției (bonul de casă) și cu o declarație în care descrieți în ce constă și când a apărut defecțiunea. Pentru a evita problemele de recepționare și costurile suplimentare, este obligatoriu să folosiți doar adresa poștală furnizată de noi. Asigurați-vă că pachetul nu este expediat cu plata la destinatar, prin Sperrgut, Express sau alți furnizori speciali. Vă rugăm să includeți și accesoriile primite în momentul achiziției și folosiți un ambalaj suficient de solid.

## Reparații-Service

Lucrările de reparații neincluse în garanție pot fi executate, contra-cost, în departamentul nostru de service. În acest sens, vom fi încântați să vă transmitem o ofertă de preț. Putem prelucra doar aparate care au fost predate suficient de bine ambalate și care poartă însemnele poștei.

**Atenție:** Vă rugăm să curățați aparatul înainte de a ni-l transmite și să atașați o notă referitor la defecțiunea în cauză.

Aparatele transmise prin servicii cu plata la destinatar sau prin Sperrgut, Express sau alți furnizori speciali nu sunt acceptate. Reciclarea aparatelor stricate predate de Dvs. se face în mod gratuit.



## Service-Center

### Service România

Tel.: 0800896637

E-Mail: grizzly@lidl.ro

IAN 78960



## Departament Service

Vă rugăm să țineți cont de faptul că următoarea adresă nu este una de service. Contactați doar centrul de service menționat mai sus.

### Technick Power KP

Pestisu Mare nr 167

331128 Hunedoara

## Περιεχόμενα

Εισαγωγή .....	38
Περιοχές εφαρμογών .....	38
Λειτουργικά εξαρτήματα .....	39
Παραδοτέα υλικά .....	39
Περιγραφή λειτουργίας .....	39
Σύνοψη .....	39
Τεχνικά στοιχεία .....	40
Υποδείξεις ασφαλείας .....	40
Επεξήγηση συμβόλων και οδηγιών ασφαλείας .....	40
Σύμβολα στις οδηγίες .....	41
Γενικές υποδείξεις ασφαλείας .....	41
Η εγκατάσταση .....	43
Συναρμολόγηση .....	43
Σύνδεση με το δίκτυο .....	43
Διακοπή .....	43
Λειτουργία ψηλής / χαμηλής πίεσης .....	44
Διακοπή λειτουργίας .....	45
Τερματισμός λειτουργίας .....	45
Χρήση καθαριστικών .....	45
Καθαρισμός / Συντήρηση .....	46
Καθαρισμός .....	46
Συντήρηση .....	46
Φύλαξη .....	46
Απόσυρση/Προστασία περιβάλλοντος .....	46
Δυσλειτουργίες - Αιτίες – Λύση .....	47
Παραγγελία ανταλλακτικών .....	47
Εγγύηση .....	48
Σέρβις επισκευής .....	49
Service-Center .....	49
Υποκατάστημα για σέρβις .....	49
Μετάφραση της πρωτότυπης Δήλωσης συμμόρφωσης CE .....	64

## Εισαγωγή



Συγχαρητήρια για την αγορά της νέας συσκευής σας.

Προτιμήσατε να αγοράσετε ένα προϊόν ανώτερης ποιότητας. Οι οδηγίες χρήσης αποτελούν αναπόσπαστο τμήμα αυτού του προϊόντος. Περιέχουν σημαντικές υποδείξεις για την ασφάλεια, τη χρήση και διάθεση της συσκευής. Πριν τη χρήση του προϊόντος να εξοικειωθείτε με όλες τις οδηγίες χειρισμού και τις υποδείξεις ασφαλείας. Να χρησιμοποιείτε το προϊόν μόνο όπως περιγράφεται και μόνο για τον αναφερόμενο σκοπό.

Να φυλάξετε καλά τις οδηγίες και να τις παραδώσετε σε τρίτους μαζί με το προϊόν.

## Περιοχές εφαρμογών

Να χρησιμοποιείτε αυτή τη συσκευή καθαρισμού υψηλής πίεσης αποκλειστικά και μόνο για χρήση στον ιδιωτικό τομέα:

- για καθαρισμό μηχανών, οχημάτων, κτιρίων, εργαλείων, προσόψεων, ταρατσών, συσκευών κήπου κλπ. με ακτίνα νερού υψηλής πίεσης.
- με γνήσια εξαρτήματα και ανταλλακτικά.
- ακολουθώντας τις οδηγίες του κατασκευαστή του προϊόντος που θα καθαριστεί.
- Αυτή η συσκευή δεν είναι κατάλληλη για επαγγελματική χρήση. Σε περίπτωση επαγγελματικής χρήσης παύει να ισχύει η εγγύηση.
- Η περιστρεφόμενη βούρτσα δεν είναι κατάλληλη για ευαίσθητες και βερνικωμένες επιφάνειες (π.χ. βερνίκια αυτοκινήτων).

## Λειτουργικά εξαρτήματα

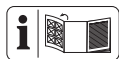

Την απεικόνιση των σημαντικότερων εξαρτημάτων λειτουργίας θα βρείτε στη σελίδα-φάκελλο.

### Παραδοτέα υλικά

Ξεπακετάρετε τη συσκευή και ελέγξτε το περιεχόμενο της συσκευασίας:

- Συσκευή καθαρισμού υψηλής πίεσης με καλώδιο για σύνδεση με το δίκτυο
- Χειρολαβή + 2 βιδες
- Σωλήνας υψηλής πίεσης σε καρούλι σωλήνα
- Άγκιστρο καλωδίου
- Στήριγμα για πιστόλι ψεκασμού
- Ταχυσύνδεσμος για αντάπτερ σωλήνα κήπου
- Πιστόλι ψεκασμού
- Ατσάλινος σωλήνας με μπεκ ψηλής πίεσης (φρέζα λυμάτων-turbo)
- Ατσάλινος σωλήνας με μπεκ επίπεδης ακτίνας (στάνταρ ακροφύσιο-Vario)
- Περιστρεφόμενη βούρτσα πλύσης
- Βελόνη καθαρισμού μπεκ
- 0,5 l καθαριστικό
- Διπλό κλειδί
- Οδηγιών χρήσης

Διαθέστε τα υλικά συσκευασίας σύμφωνα με τους κανονισμούς.

### Περιγραφή λειτουργίας

Το πλυστικό υψηλής πίεσης καθαρίζει με ακτίνα νερού, κατ'επιλογή με υψηλή ή χαμηλή πίεση.

Εάν χρειαστεί, προσθέτετε καθαριστικά.

Για τη λειτουργία των τμημάτων χειρισμού διαβάστε τις ακόλουθες περιγραφές. Προσέξτε τις υποδείξεις ασφαλείας.

## Σύνοψη

- A**
- 1 Πιστόλι ψεκασμού
  - 2a Χειρολαβή
  - 2b 2 βιδες
  - 3 Σωλήνας υψηλής πίεσης σε καρούλι σωλήνα
  - 4 Μανιβέλα για καρούλι σωλήνα
  - 5 Άγκιστρο καλωδίου
  - 6 Καλώδιο:
  - 7 Τροχοί
  - 8 Σίτα
  - 9 Σύνδεση νερού
  - 10 Διακόπτης ενεργοποίησης/ απενεργοποίησης
  - 11 Στήριγμα για πιστόλι ψεκασμού
  - 12 Σύνδεση υψηλής πίεσης πλευρά πιπιολιού
  - 13 Ταχυσύνδεσμος για αντάπτερ σωλήνα κήπου
  - 14 Οπή δοχείου καθαριστικού
  - 15 Δοχείο καθαριστικού
  - 16 Στήριγμα για αξεσουάρ
  - 17 Ατσάλινος σωλήνας με μπεκ ψηλής πίεσης (φρέζα λυμάτων-turbo)
  - 18 Ατσάλινος σωλήνας με μπεκ επίπεδης ακτίνας (στάνταρ ακροφύσιο-Vario)
  - 19 Περιστρεφόμενη βούρτσα πλύσης
  - 20 Βελόνη καθαρισμού μπεκ
  - 21 Καθαριστικό
  - 22 Διπλό κλειδί
- B**
- 23 Κουμπί ασφάλισης
  - 24 Μοχλός ενεργοποίησης

## Τεχνικά στοιχεία

**συσκευή καθαρισμού υψηλής πίεσης** ..... **PHD 150 B2**

Θλεκτρική σύνδεση ..... 230V~, 50 Hz

Ισχύς λήψης ..... 2100 W

Όνομασία ..... 5 m

Βάρος ..... 10,8 kg

Κλάση προστασίας .....  II

Είδος προστασίας ..... IPX5

Προδιαγεγραμμένη πίεση/πίεση λειτουργίας (p) ..... 11 MPa

Μέγ. επιτρεπτή πίεση (p max) ..... 15 MPa

Μέγ. πίεση εισαγωγής (p in max) ..... 0,8 MPa

Μέγ. Θερμοκρασία παροχής (T in max) ..... 40°C

Ποσότητα μεταφοράς, νερό (Q) ... 5,5 l/min

Μέγ. ποσότητα μεταφοράς, νερό (Q max) ..... 7,5 l/min

Στάθμη πίεσης ήχου (L<sub>PA</sub>) ..... 78,2 dB(A); K<sub>PA</sub> = 3,0 dB(A)

Επιτρεπόμενη στάθμη θορύβου (L<sub>WA</sub>) εγγυημένη ..... 98,0 dB(A)

μετρημένη ... 91,7 dB(A); K<sub>WA</sub> = 3,0 dB(A)

Δόνηση (a<sub>n</sub>) ..... 0,496 m/s<sup>2</sup>; K=1,5 m/s<sup>2</sup>

Αυτή η συσκευή προορίζεται για λειτουργία σε δίκτυο τροφοδοσίας ρεύματος με αντίσταση συστήματος Z<sub>max</sub> στο σημείο μετάβασης (σύνδεση οικιακού δικτύου) μέγιστου 0,277 Ohm.

Ο χρήστης πρέπει να εξασφαλίζει το ότι η συσκευή λειτουργεί μόνο σε δίκτυο που πληροί τις απαιτήσεις.

Εάν χρειαστεί, ενημερωθείτε για την αντίσταση του συστήματος στην τοπική σας εταιρεία παροχής ρεύματος.

Υπάρχει δυνατότητα τεχνικών και οπτικών αλλα-γών χωρίς προηγούμενη ειδοποίηση στα πλαίσια της εξέλιξης. Ως εκ τούτου, όλα τα μέτρα, οι υποδείξεις καθώς και τα στοιχεία των παρόντων οδηγιών χρήσης δεν παρέχουν εγγύηση. Οι νομικές αξιώσεις, οι οποίες εγείρονται με αφορμή της οδηγίας χρήσης, δεν μπορούν να επικαλ-εστούν για το λόγο αυτό.

## Υποδείξεις ασφαλείας

Στο κεφάλαιο αυτό θα βρείτε όλες τις βασικές προδιαγραφές ασφαλείας που ισχύουν κατά την εργασία σας με τη συσκευή καθαρισμού υψηλής πίεσης.

### Επεξήγηση συμβόλων και οδηγιών ασφαλείας



Προσοχή!



Εξοικειωθείτε καλά πριν από την εργασία με όλα τα στοιχεία χειρισμού, ιδιαίτερα με τις λειτουργίες και τις επενέργειες. Ρωτήστε ενδεχ. κάποιον ειδικό Διαβάστε προσεκτικά τις οδηγίες χρήσης, που σχετίζονται με τη συσκευή!



Προσοχή! Σε περιπτώσεις που το καλώδιο έπαθε ζημία ή έχει κοπεί να βγάξετε αμέσως το ρευματολήπτη από τη πρίζα. Όταν συνδέετε τη συσκευή με την παροχή νερού και όταν προσπαθείτε να επισκευάσετε διαρροές να βγάξετε το βύσμα από την πρίζα.



Συσκευή ακατάλληλη για σύνδεση σε σύστημα τροφοδότησης πόσιμου νερού.



Κατηγορία προστασίας II



Οι συσκευές δεν επιτρέπεται να καταλήγουν στα οικιακά απορρίμματα.



Οι συσκευές καθαρισμού υψηλής πίεσης μπορούν να είναι επικίνδυνες εάν δεν χρησιμοποιηθούν σωστά. Ποτέ να μη τείνετε την ακτίνα προς ανθρώπους, ζώα, ενεργό ηλεκτρικό εξοπλισμό ή προς την ίδια τη συσκευή.





Η συσκευή να λειτουργεί μόνο όρθια και ποτέ σε πλάγια θέση.



Οι συσκευές καθαρισμού υψηλής πίεσης μπορούν να είναι επικίνδυνες εάν δεν χρησιμοποιηθούν σωστά. Ποτέ να μη τείνετε την ακτίνα προς ανθρώπους, ζώα, ενεργό ηλεκτρικό εξοπλισμό ή προς την ίδια τη συσκευή.

## Σύμβολα στις οδηγίες



**Σύμβολα κινδύνου με στοιχεία για την πρόληψη προσωπικών και υλικών ζημιών.**



Σύμβολο υποχρέωσης (στη θέση του συμβόλου έκτακτης ανάγκης επεξηγείται η αντίστοιχη υποχρέωση) με στοιχεία για την πρόληψη ζημιών.



Σύμβολο υπόδειξης με πληροφορίες για τον καλύτερο χειρισμό της συσκευής.

## Γενικές υποδείξεις ασφαλείας

- Η συσκευή αυτή δεν προορίζεται για τη χρήση από άτομα (συμπεριλαμβανομένων παιδιών) με περιορισμένες φυσικές, αισθητικές και νοητικές ικανότητες ή από άτομα με έλλειψη εμπειρίας και/ή γνώσης; εκτός και αν επιτηρούνται από κάποιο άτομο υπεύθυνο για την ασφάλειά τους ή λαμβάνουν από αυτό οδηγίες σχετικά με το χειρισμό της συσκευής.
- Επιπληρείτε τα παιδιά, για να είστε σίγουροι πως δεν παίζουν με τη συσκευή.
- Δεν επιτρέπεται να χρησιμοποιούν τη συσκευή πρόσωπα που δεν είναι εξοικειωμένα με τις οδηγίες χειρισμού. Δεν επιτρέπεται να χειρίζονται τη συσκευή άτομα κάτω των 16 ετών.
- Να χρησιμοποιείτε τη συσκευή μόνο όρθια σε επίπεδη και ανθεκτική επιφάνεια.
- Μη τείνετε την ακτίνα προς τον εαυτό σας ή προς άλλα άτομα για να καθαρίσετε ρούχα ή παπούτσια.
- Για προστασία από πιτσιλιές νερού ή ακαθαρσιών να χρησιμοποιείτε κατάλληλα προστατευτικά ρούχα και προστατευτικά γυαλιά.
- Μη χρησιμοποιείτε τη συσκευή, όταν βρίσκονται κοντά σας άλλα άτομα, εκτός εάν φορούν προστατευτικό ρουχισμό.
- Λάβετε τα αναγκαία μέτρα ώστε τα παιδιά να παραμένουν μακριά από τη συσκευή, όταν αυτή βρίσκεται σε λειτουργία.
- Αποσύρετε το υλικό συσκευασίας σύμφωνα με τους κανονισμούς.
- Εάν έρθετε σε επαφή με καθαριστικά, ξεπλύνετε αμέσως με άφθονο νερό.
- Μη ψεκάζετε εύφλεκτα υγρά. Υφίσταται κίνδυνος έκρηξης
- Μη χρησιμοποιείτε τη συσκευή κοντά σε εύφλεκτα υγρά ή αέρια. Σε περίπτωση μη συμμόρφωσης με την υπόδειξη αυτή, υφίσταται κίνδυνος πυρκαγιάς ή έκρηξης.
- Φυλάσσετε τη συσκευή σε ένα ξηρό μέρος και εκτός της εμβέλειας των παιδιών.

## Εργασία με τη συσκευή



Προσοχή! Έτσι θα αποφύγετε ατυχήματα και τραυματισμούς:



Προσοχή! Έτσι θα αποφύγετε ζημιές της συσκευής και ενδεχόμενες συνακόλουθες ζημιές προσώπων:

- Μην εργάζεστε με συσκευές που έχουν υποστεί ζημιές, που δεν είναι πλήρεις ή

που τροποποιήθηκαν χωρίς την έγκριση του κατασκευαστή. Πριν από τη θέση σε λειτουργία, δώστε εντολή σε κάποιον ειδικό να ελέγξει, αν είναι διαθέσιμα όλα τα απαιτούμενα ηλεκτρικά μέτρα προστασίας.

- Μη χρησιμοποιείτε τη συσκευή σε περίπτωση που είναι ελαττωματικός ή δεν είναι στεγανός ο αγωγός σύνδεσης με το δίκτυο, η παροχή νερού ή άλλα σημαντικά εξαρτήματα όπως ο σωλήνας υψηλής πίεσης ή το πιστόλι ψεκασμού.
- Να προστατεύετε τη συσκευή από παγετό και στεγνή λειτουργία.
- Οι σωλήνες υψηλής πίεσης, οι βάνες και οι σύνδεσμοι είναι εξαιρετικά σημαντικοί για την ασφάλεια της συσκευής. Να χρησιμοποιούνται μόνο οι σωλήνες υψηλής πίεσης, βάνες και σύνδεσμοι που συνιστώνται από τον κατασκευαστή.
- Χρησιμοποιείτε μόνο αυθεντικά εξαρτήματα και μη διεξάγετε τροποποιήσεις στη συσκευή.
- Η συσκευή να ανοίγεται μόνο από ηλεκτρολόγο ειδικά εγκεκριμένο. Σε περίπτωση ανάγκης επισκευής, αποταθείτε στο Κέντρο Σέρβις μας.

## Ηλεκτρική ασφάλεια:



**Προσοχή:** Έτσι θα αποφύγετε ατυχήματα και τραυματισμούς οφειλόμενα σε ηλεκτροπληξία:

- Σε περίπτωση χρήσης μπαλαντέζας πρέπει το βύσμα και η σύνδεση να είναι υδατοστεγανή.



Ακατάλληλες μπαλαντέζες αποτελούν ενδεχομένως κίνδυνο. Υφίσταται κίνδυνος τραυματισμών από ηλεκτροπληξία.

- Να προστατεύετε τις ηλεκτρικές συνδέσεις από υγρασία.
- Σε περίπτωση που υπάρχει κίνδυνος πλημμύρας, φέρτε τις συνδέσεις σε

περιοχές ασφαλείς από υπερχειλίσεις.

- Φροντίστε ώστε η τάση του ρεύματος να συμφωνεί με τα στοιχεία της πινακίδας τύπου.
- Η σύνδεση με το δίκτυο να γίνει μόνο από έμπειρο ηλεκτρολόγο και να πληροί τις απαιτήσεις του IEC 60364-1.
- Να συνδέετε τη συσκευή μόνο σε πρίζα με διακόπτη διαρροής με ευαισθησία όχι πάνω από 30 mA, ασφάλεια τουλάχιστον 13 αμπέρ.
- Αν το καλώδιο ρεύματος της συσκευής αυτής φθαρεί, πρέπει να αντικατασταθεί από έναν άλλο, ειδικό καλώδιο ρεύματος, μέσω του κατασκευαστή, της υπηρεσίας εξυπηρέτησης πελατών αυτού ή ενός όμοια καταρτισμένου προσώπου, έτσι ώστε να αποφευχθούν ενδεχόμενοι κίνδυνοι.
- Μη χρησιμοποιείτε το καλώδιο για να τραβήξετε το φως από την πρίζα. Προστατεύετε το καλώδιο από τη ζέστη, έλαια και αιχμηρές γωνίες.
- Μη μεταφέρετε και μη στερεώνετε τη συσκευή από το καλώδιο.

Χρησιμοποιείτε μόνο καλώδια προέκτασης που διαθέτουν προστασία πισισίματος και προορίζονται για εξωτερική χρήση. Ξετυλίγετε πάντα την μπομπίνα του καλωδίου εντελώς πριν τη χρήση. Ελέγχετε το καλώδια για ενδεχόμενες ζημιές.

- Πριν από κάθε εργασία στη συσκευή, κατά τα διαλείμματα και όταν δε χρησιμοποιείτε τη συσκευή, βγάξτε πάντα το φως από την πρίζα.
- Τα καλώδια σύνδεσης με το δίκτυο δεν επιτρέπεται να έχουν μικρότερη διατομή από  $2 \times 2,5 \text{ mm}^2$ .
- Για προστασία από ηλεκτροπληξία να φοράτε γερά παπούτσια.
- Για προστασία από ηλεκτροπληξία να χρησιμοποιείτε τη συσκευή μόνο σε όρθια στάση.

## Η εγκατάσταση



Σύμφωνα με τις ισχύουσες διατάξεις δεν επιτρέπεται να χρησιμοποιηθεί η συσκευή καθαρισμού υψηλής πίεσης ποτέ χωρίς διαχωριστικό συστήματος στο δίκτυο πόσιμο νερού. Να χρησιμοποιείται κατάλληλο διαχωριστικό συστήματος σύμφωνα με EN 12729 τύπου BA.

Το νερό που περνάει από έναν διαχωριστή συστήματος δεν θεωρείται πλέον ως πόσιμο νερό.

Θα βρείτε διαχωριστικό συστήματος στα ειδικά καταστήματα.

- Για την παροχή του νερού χρησιμοποιήστε ένα κοινό λάστιχο νερού και προσέξτε να έχει αρκετό μήκος.
- Να χρησιμοποιείτε τη συσκευή σε παροχή νερού του σπιτιού ή σε πηγή νερού με ελάχιστη ταχύτητα ροής 450 l/h.

## Συναρμολόγηση

1. Ωθήστε τη χειρολαβή (2a) στους τετραγώνους σωλήνες του πλαισίου. Η χειρολαβή (2a) κουμπώνει με κλικ. Ασφαλίστε τη χειρολαβή (2a) με τις δύο συμπαραδιδόμενες βίδες (2b) από την όπισθεν.
2. Σπρώξτε το άγκιστρο για το καλώδιο (5) και το στήριγμα για το πιστόλι ψεκασμού (11) στους οδηγούς στο κέλυφος της συσκευής.
3. Βιδώστε τη σύνδεση υψηλής πίεσης του πιστολιού ψεκασμού (12) με το πιστόλι ψεκασμού (1). Χρησιμοποιήστε το συμπαραδιδόμενο διπλό κλειδί.
4. Συνδέστε τον σωλήνα πρώτα στην παροχή νερού και αφήστε να εξέλθει το νερό χωρίς φυσαλλίδες από την άλλη άκρη του σωλήνα, έτσι ώστε να γίνει αερισμός του σωλήνα. Κλείστε τη βρύση.
5. Συνδέστε τον σωλήνα με τη βοήθεια του ταχυσύνδεσμου για τον αντάπτορα

σωλήνα κήπου (13) με τη σύνδεση παροχής νερού (9) στη συσκευή. Να χρησιμοποιείτε πάντα μία σήτα (8) και να την καθαρίζετε όταν χρειαστεί.

6. Συνδέστε πιέζοντας και βιδώνοντας τον ασάλινο σωλήνα με το μπεκ υψηλής πίεσης (17) ή κατ'επιλογή τον ασάλινο σωλήνα με το μπεκ επίπεδης ακτίνας (18) ή την περιστρεφόμενη βούρτσα (19) με το πιστόλι ψεκασμού.
7. Η αλλαγή ενός ασάλινου σωλήνα (17/18) ή της περιστρεφόμενης βούρτσας (19) γίνεται με πίεση και βιδώμα προς την αντίθετη κατεύθυνση.

## Σύνδεση με το δίκτυο

Η συσκευή καθαρισμού υψηλής πίεσης που αγοράσατε διαθέτει ήδη ένα βύσμα δικτύου. Η συσκευή προορίζεται για σύνδεση σε πρίζα σούκο με διακόπτη ασφαλείας (FI) 230V ~ 50 Hz.



Να θέτετε τη συσκευή σε λειτουργία μόνο αφού προσέξετε τις προαναφερθείσες υποδείξεις.

1. Σιγουρευθείτε πως η συσκευή καθαρισμού υψηλής πίεσης έχει απενεργοποιηθεί με το διακόπτη ενεργοποίησης / απενεργοποίησης (10).
2. Βάλτε το φως στην πρίζα.

## Διακοπή



**Λάβετε υπόψη σας τη δύναμη ανάκρουσης της εξερχόμενης ακτίνας νερού. Φροντίστε να στέκεστε σε σταθερό σημείο και κρατάτε γερά το πιστόλι ψεκασμού. Διαφορετικά δεν αποκλείεται να τραυματίσετε τον εαυτό σας ή και άλλα άτομα.**



Μη λειτουργείτε τη συσκευή καθαρισμού υψηλής πίεσης με κλειστή τη βρύση του νερού. Μία στεγνή

Λειτουργία θα προκαλέσει ζημιά της συσκευής.

1. Ανοίξτε τελείως τη βρύση νερού
2. Ενεργοποιήστε τη συσκευή καθαρισμού υψηλής πίεσης με τον διακόπτη ενεργοποίησης / απενεργοποίησης (10). Να ενεργοποιείτε τον καθαριστήρα υψηλής πίεσης μόνο αφού συνδέσετε όλους τους αγωγούς του νερού και εφόσον είναι όλοι στεγανοί.

Ο κινητήρας παίρνει μπροστά όταν δημιουργηθεί η απαιτούμενη πίεση. Αφού δημιουργηθεί η πίεση σβήνει ο κινητήρας.

3. Πιέστε το μοχλό ενεργοποίησης του πιστολιού (1). Το μπεκ λειτουργεί με πίεση και ο κινητήρας παίρνει πάλι μπροστά. Εάν αφήσετε ελεύθερο τον μοχλό ενεργοποίησης, σβήνει η συσκευή. Η υψηλή πίεση παραμένει στο σύστημα.

- Ο ασάλινος σωλήνας με το μπεκ ψηλής πίεσης (17) είναι χάρη στην περιστρεφόμενη ακτίνα νερού ιδιαίτερα κατάλληλος για εργασία με χαμηλή κατανάλωση νερού.
- Ο ασάλινος σωλήνας με το μπεκ επίπεδης ακτίνας (18) είναι χάρη στην επίπεδη ακτίνα ιδιαίτερα κατάλληλος για καθαρισμό επιφανειών.

Με περιστροφή του άκρου του μπεκ προς τα αριστερά μπορείτε να μειώσετε το πλάτος της ακτίνας. Με περιστροφή του άκρου του μπεκ προς τα δεξιά μπορείτε να μεγαλώσετε το πλάτος της ακτίνας.



**Σε περίπτωση διαρροής στο σύστημα νερού, απενεργοποιήστε αμέσως τη συσκευή με τον διακόπτη ενεργοποίησης/απενεργοποίησης (10) και διακόψτε την παροχή ρεύματος (6). Κίνδυνος ηλεκτροπληξίας. Αρχίστε και πάλι με τις συνδέσεις του νερού από το εδάφιο 4 και πέρα (βλ. «Η εγκατάσταση / Συναρμολόγηση»).**



**Εάν υπάρχει ακόμη αέρας στη συσκευή, ακολουθήστε τα εξής βήματα:**

#### **Εξαερισμός του σωλήνα σύνδεσης:**

1. Αφαιρέστε τον ταχυσύνδεσμο για την παροχή νερού (13) στη σύνδεση νερού (9) και ανοίξτε τη βρύση του νερού, μέχρι να εξέλθει το νερό χωρ'ί φυσαλλίδες.
2. Κλείστε τη βρύση.
3. Συνδέστε τον σωλήνα με τη βοήθεια του ταχυσύνδεσμου για τον αντάπτορα σωλήνα κήπου (13) με τη σύνδεση παροχής νερού (9) στη συσκευή.
4. Ανοίξτε τελείως την παροχή νερού

#### **Εξαερισμός της συσκευής:**

5. Ανάψτε τον διακόπτη ON/OFF (10) μέχρι να μην υπάρχει πίεση.
6. Σβήστε τον διακόπτη ON/OFF (10).
7. Πιέστε το μοχλό ενεργοποίησης του ψεκαστικού πιστολιού (1) μέχρι να απαλειφθεί η πίεση.
8. Να επαναλάβετε τη διαδικασία 5. έως 7. μέχρι να μην υπάρχει πλέον αέρας στη συσκευή.

### **Λειτουργία ψηλής / χαμηλής πίεσης**

Ο ασάλινος σωλήνας με μπεκ επίπεδης ακτίνας (18) προορίζεται για την κατά επιλογή λειτουργία με ψηλή και χαμηλή πίεση.

Στη στάντα ρύθμιση λειτουργεί το ρυθμιζόμενο μπεκ επίπεδης ακτίνας με ψηλή πίεση.

Μπορείτε να στρώξετε το άκρο του μπεκ προς τα εμπρός και έτσι να αλλάξετε στη λειτουργία χαμηλής πίεσης.

Σε αυτό το είδος λειτουργίας (χαμηλή πίεση) αναρροφάται το καθαριστικό αυτόματα από το ενσωματωμένο δοχείο (βλ. «Χρήση καθαριστικών»).

Μία αλλαγή στη λειτουργία ψηλής πίεσης γίνεται με τοποθέτηση του άκρου του μπεκ.

B

- Μπορείτε κατ'επιλογή να κλειδώσετε ή να ξεκλειδώσετε το μοχλό ενεργοποίησης του ψεκαστήρα (1) με πίεση του κουμπιού κλειδώματος (23).

**Με κλειδώμα του μοχλού ενεργοποίησης αποφεύγετε μία αθέλητη έναρξη λειτουργίας της συσκευής.**



κλειδωμένο

ανοικτό

## Διακοπή λειτουργίας

- Αφήστε ελεύθερο τον μοχλό του πιστολιού (1).
- Σε περίπτωση μεγαλύτερων διαλειμμάτων εργασίας να απενεργοποιείτε τον διακόπτη ενεργοποίησης/απενεργοποίησης (10).



**Εάν πέσει η συσκευή, απενεργοποιήστε αμέσως τη συσκευή με τον διακόπτη ενεργοποίησης/απενεργοποίησης (10) και διακόψτε την παροχή ρεύματος (6). Κίνδυνος ηλεκτροπληξίας. Τώρα επαναστήστε τη συσκευή σε όρθια θέση. Για δική σας ασφάλεια περιμένετε περ. πέντε λεπτά μέχρι να συνδέσετε τη συσκευή με το ρεύμα.**

## Τερματισμός λειτουργίας

- Μετά από εργασία με καθαριστικά, να ξεπλύνετε το σύστημα με καθαρό νερό.
- Αφήστε ελεύθερο το μοχλό στο πιστόλι ψεκασμού (1).
- Απενεργοποιήστε τη συσκευή ψεκασμού υψηλής πίεσης με τον διακόπτη

ενεργοποίησης / απενεργοποίησης (10). Βγάλτε το βύσμα από την πρίζα.

- Κλείστε τη βρύση του νερού.
- Διακόψτε την παροχή νερού προς τη συσκευή καθαρισμού υψηλής πίεσης.
- Τραβήξτε το μοχλό του πιστολιού ψεκασμού (1), για να εκκενωθεί η πίεση στο σύστημα.

## Χρήση καθαριστικών

Η συσκευή αυτή αναπτύχθηκε και κατασκευάστηκε για τη χρήση με ουδέτερο καθαριστικό με βάση βιολογικά αποσυντιθέμενα ανιονικά επιφανειοδραστικά. Η χρήση άλλων καθαριστικών ή χημικών ουσιών μπορεί να μειώσει την ασφάλεια της συσκευής και να προκαλέσει ζημιές. Παρόμοιες βλάβες δεν καλύπτονται από την εγγύηση.

## Πλήρωση με καθαριστικό/εκκένωση καθαριστικού:

- Για τη χρήση καθαριστικού πρέπει να βρίσκεται καθαριστικό στο δοχείο καθαριστικού (15).
- Για την αφαίρεση του δοχείου καθαριστικού (15) πιάστε το δοχείο από το πλαίικαι σπρώξτε τον προς τα επάνω. Τώρα μπορείτε να αφαιρέσετε το δοχείο καθαριστικού από τον κάτω και πλαινό οδηγό του και να το βγάλετε από τη συσκευή καθαρισμού υψηλής πίεσης. Να απομακρύνετε επίσης στην οπή του δοχείου με το καθαριστικό μέσο (14) και το σωλήνα αναρρόφησης με το πώμα του. Αυτά τα εξαρτήματα παραμένουν στη συσκευή καθαρισμού υψηλής πίεσης.
- Για να επανατοποθετήσετε το δοχείο καθαριστικού, ακολουθήστε τις πιο πάνω οδηγίες στην αντίστροφη σειρά.

## Δουλεύω:

- Όταν χρησιμοποιείτε τον ασάλινο σωλήνα με το μπεκ επίπεδης ακτίνας (18) στη λειτουργία χαμηλής πίεσης, αναρ-

- ροφάται το καθαριστικό αυτόματα.
- Η περιστρεφόμενη βούρτσα (19) λειτουργεί πάντα στη λειτουργία χαμηλής πίεσης και έτσι αναρροφά πάντα το αθαριστικό.
- Εάν θέλετε να χρησιμοποιήσετε την περιστρεφόμενη βούρτσα (19) χωρίς καθαριστικό, πρέπει να αφαιρέσετε το δοχείο καθαριστικού (15).

## Καθαρισμός / Συντήρηση



Πριν από οποιαδήποτε εργασία συντήρησης βγάξτε το κορδόνι γραμμής. Υφίσταται κίνδυνος ηλεκτροπληξίας ή τραυματισμού από κινούμενα τμήματα.

## Καθαρισμός



**Μη πλένετε τη συσκευή με νερό και μη την καθαρίζετε κάτω από πόσιμο νερό. Υφίσταται κίνδυνος ηλεκτροπληξίας και βλάβης της συσκευής.**

**Να διατηρείτε τη συσκευή πάντα καθαρή. Μη χρησιμοποιείτε καθαριστικά ή διαλύτες.**

- Να διατηρείτε τις σχισμές αέρα πάντα καθαρές και ελεύθερες.
- Να καθαρίζετε τη συσκευή με μία μαλακιά βούρτσα ή με ένα ελαφρά νωπό πανί.
- Εάν ένα από τα μπεκ στον ασφάλινο σωλήνα (17/18) είναι βουλωμένο, μπορείτε με τη βελόνα καθαρισμού των μπεκ (20) να αφαιρέσετε το ξένο αντικείμενο από το μπεκ.

## Συντήρηση

Η συσκευή καθαρισμού υψηλής πίεσης δεν χρειάζεται συντήρηση.



**Αναθέστε τις εργασίες που δεν περιγράφονται στις οδηγίες αυτές στο Κέντρο Σέρβις της εται-**

**ρίας μας. Χρησιμοποιείτε μόνο αυθεντικά εξαρτήματα.**

## Φύλαξη

- Αδειάστε τη συσκευή καθαρισμού με υψηλή πίεση τελειώς από το νερό. διακόψτε την παροχή νερού. Ενεργοποιήστε τη συσκευή καθαρισμού υψηλής πίεσης με τον διακόπτη ενεργοποίησης/απενεργοποίησης (10) για το ανώτερο 1 λεπτό, μέχρι να μην εξέρχεται πλέον νερό από τη σύνδεση ψηλής πίεσης στην πλευρά της συσκευής. Απενεργοποιήστε τη συσκευή.
- Η συσκευή καθαρισμού υψηλής πίεσης και τα εξαρτήματα καταστρέφονται από παγετό, εάν δεν έχει εκκενωθεί τελειώς το νερό.
- Να φυλάγετε τη συσκευή καθαρισμού υψηλής πίεσης και τα εξαρτήματα σε χώρο με θερμοκρασία πάνω από το μηδέν.

## Απόσυρση/Προστασία περιβάλλοντος

Αποσύρετε συσκευή, εξαρτήματα και συσκευασία με οικολογικό τρόπο ανακύκλωσης.



Οι συσκευές δεν επιτρέπεται να καταλήγουν στα οικιακά απορρίμματα.

Αποσύρετε τη συσκευή σε κατάλληλη υπηρεσία ανακύκλωσης. Τα χρησιμοποιηθέντα συνθετικά υλικά και μεταλλικά εξαρτήματα διαχωρίζονται και μπορεί να γίνει επανεκμετάλλυσή τους. Για πληροφορίες απευθυνθείτε στο Κέντρο Σέρβις.

## Δυσλειτουργίες - Αιτίες – Λύση

Πρόβλημα	Ενδεχόμενη αιτία	Αποκατάσταση
Δεν λειτουργεί η συσκευή	Απενεργοποιημένος διακόπτης ενεργοποίησης/απενεργοποίησης (10)	Έλεγχος θέσης διακόπτη ενεργοποίησης / απενεργοποίησης (10)
	Ελαττωματικό καλώδιο σύνδεσης με το δίκτυο (6)	Απενεργοποιήστε τη συσκευή και διακόψτε την παροχή ρεύματος. Έλεγχος καλωδίου σύνδεσης με το δίκτυο (6) για ενδεχόμενες βλάβες. Ενδεχομένως να αντικατασταθεί το καλώδιο από ειδικευμένο τεχνίτη.
	Ελαττωματική τροφοδοσία τάσης	Έλεγχος της ηλεκτρικής εγκατάστασης για συμφωνία με τα στοιχεία στην ετικέτα της συσκευής
Η συσκευή δεν έχει πίεση	Εγκλωβισμένος αέρας στη συσκευή καθαρισμού με υψηλή πίεση	Ενεργοποιήστε τη συσκευή με το πιστόλι ψεκασμού και χωρίς μπεκ, μέχρι να εξέλθει από την έξοδο ψηλής πίεσης νερό χωρίς αεροφουσαλίδες.
	Ελάττωση πίεσης στον αγωγό	Έλεγχος της τροφοδοσίας τάσης
Μεγάλες διακυμάνσεις πίεσης	Ρύπτοι στο μπεκ υψηλής πίεσης (17)	Ξεπλύνετε το μπεκ υψηλής πίεσης (17) με νερό. Με μία βελόνα να καθαρίζετε την οπή του μπεκ αν χρειαστεί.
Διαρροή στο σύστημα νερού	Δεν έχει γίνει σωστή σύνδεση	Απενεργοποιήστε τη συσκευή και διακόψτε την παροχή ρεύματος. Συνδέστε τη συσκευή με τους αγωγούς παροχής νερού (βλ. „Θέση σε λειτουργία-Εγκατάσταση“)
	Διαρροή στη σύνδεση παροχής νερού (9)	Απενεργοποιήστε τη συσκευή και διακόψτε την παροχή ρεύματος. Αντικαταστήστε τη σύνδεση νερού (9) και τον στεγανοδακτύλιο συμπερ. και του στεγανοδακτυλίου (βλ. „Ανταλλακτικά“)

## Παραγγελία ανταλλακτικών

Για την αγορά ανταλλακτικών χρησιμοποιείτε την αναφερόμενη διεύθυνση σέρβις ή τον αριθμό τέλεφαξ. Κατά την παραγγελία σας παρακαλούμε να αναφέρετε τον τύπο μηχανής και τον κωδικό είδους του ανταλλακτικού ή τον αριθμό θέσης.

<b>A</b>	<b>Αρ. Χαρακτηρισμός.....</b>	<b>Αρ. είδους</b>
1	Πιστόλι ψεκασμού.....	91097399
3	Σωλήνας ψηλής πίεσης .....	91097400
13	Ταχζύνδεσμος παροχής νερού .....	91097401
17	Ατσάλινος σωλήνας με μπεκ ψηλής πίεσης .....	91097403
18	Ατσάλινος σωλήνας με μπεκ επίπεδης ακτίνας.....	91097404
19	Περιστρεφόμενη βούρτσα.....	91097405
9	Σύνδεση νερού με σίτα.....	91097408

## Εγγύηση

Αξιότιμη πελάτισσα, αξιότιμε πελάτη, για τη συσκευή αυτή σας προσφέρουμε εγγύηση 3 ετών από την ημερομηνία της αγοράς. Σε περίπτωση ελαττωμάτων αυτού του προϊόντος, έχετε απέναντι του πωλητή τα νόμιμα δικαιώματα. Αυτά τα νόμιμα δικαιώματα δεν περιορίζονται από την επακόλουθη εγγύησή μας.

### Όροι εγγύησης

Η προθεσμία της εγγύησης αρχίζει από την ημερομηνία της αγοράς. Παρακαλούμε να φυλάξετε καλά την απόδειξη αγοράς. Θα σας χρειαστεί εάν θελήσετε να αποδείξετε την ημερομηνία και την αγορά της συσκευής. Εάν παρουσιαστεί ελάττωμα υλικού ή κατασκευής στο προϊόν αυτό εντός τριών ετών από την ημερομηνία αγοράς, θα σας επισκευάσουμε ή θα σας αντικαταστήσουμε δωρεάν το προϊόν αυτό, με δική μας επιλογή. Αυτή η παροχή εγγύησης προϋποθέτει πως εντός της τριετούς προθεσμίας θα μας προσκομιστεί η ελαττωματική συσκευή και η απόδειξη αγοράς και μία γραπτή περιγραφή του ελαττώματος και της ημερομηνίας που πρωτοπαρουσιάστηκε.

Εάν το ελάττωμα καλύπτεται από την εγγύησή μας, θα σας επιστραφεί ή το επισκευασμένο ή ένα νέο προϊόν. Με την επισκευή ή αντικατάσταση του προϊόντος δεν αρχίζει νέα περίοδος εγγύησης.

### Διάρκεια εγγύησης και νόμιμες αξιώσεις για ελαττώματα

Η διάρκεια της εγγύησης δεν επεκτείνεται από την παροχή εγγύησης. Αυτό ισχύει και για αντικαταστημένα και επισκευασμένα εξαρτήματα. Ενδεχόμενα ελαττώματα που διαπιστώνονται κατά την αγορά, πρέπει να δηλωθούν αμέσως μετά το ξεπακετάρισμα. Για όλες τις επισκευές που καθίστανται απαραίτητες μετά τη λήξη της εγγύησης επιβαρύνεστε με τις σχετικές δαπάνες.

### Έκταση της εγγύησης

Η συσκευή κατασκευάστηκε βάσει αυστηρών κριτηρίων ποιότητας και ελέγχθηκε ευσυνείδητα πριν την παράδοσή της.

Η εγγύηση ισχύει για ελαττώματα στο υλικό ή στην κατασκευή. Αυτή η εγγύηση δεν συμπεριλαμβάνει τμήματα του προϊόντος που υφίστανται κοινή φθορά και θεωρούνται ως αναλώσιμα (π.χ. φίλτρα ή ένθετα εργαλεία) ή εύθραυστα τμήματα του προϊόντος (π.χ. διακόπτες, μπαταρίες ή γυάλινα τμήματα).

Αυτή η εγγύηση εκπίπτει σε περίπτωση που η συσκευή υπέστη βλάβη, δεν χρησιμοποιήθηκε ή δεν συντηρήθηκε σωστά. Για σωστή χρήση του προϊόντος πρέπει να ακολουθούνται όλες οι υποδείξεις που αναφέρονται στις οδηγίες χρήσης. Να αποφεύγονται οπωσδήποτε οι χρήσεις και πράξεις που δεν συνιστώνται στις Οδηγίες χρήσης ή για τις οποίες ισχύουν ειδικές προειδοποιήσεις. Το προϊόν προορίζεται μόνο για ιδιωτική και όχι για επαγγελματική χρήση. Σε περίπτωση καταχρηστικού και λάθους χειρισμού, άσκησης βίας και επεμβάσεων που δεν εκτελούνται από συμβεβλημένο συνεργείο μας, εκπίπτει η εγγύηση.

### Διακανονισμός σε περίπτωση εγγύησης

Προς εξασφάλιση ταχείας επεξεργασίας παρακαλούμε να ακολουθήσετε τις επόμενες υποδείξεις:

- Για όλα τα αιτήματα να έχετε πρόχειρα την απόδειξη αγοράς και τον αριθμό προϊόντος (π.χ. IAN 12345) ως αποδεικτικό στοιχείο για την αγορά.
- Τον αριθμό προϊόντος θα τον βρείτε στην επικέτα στοιχεία της συσκευής, σε χαραγμένη σημείωση στο προϊόν, στο εξώφυλλο των Οδηγιών χρήσης (κάτω αριστερά) ή σαν αυτοκόλλητο στην πίσω ή κάτω πλευρά.
- Εάν παρουσιαστούν σφάλματα λειτουργίας ή άλλα ελαττώματα, επικοινωνήστε πρώτα με το πιο κάτω αναφερόμενο τμήμα εξυπηρέτησης πελατών **τηλεφω-**



**νικά** ή με **e-mail**. Εκεί θα σας δοθούν περισσότερες πληροφορίες για τον διακανονισμό.

- Ένα ως ελαττωματικό καταχωρημένο προϊόν μπορείτε, μετά από συνεννόηση με το τμήμα μας εξυπηρέτησης πελατών, να το στείλετε, με δική μας επιβάρυνση με τα ταχυδρομικά, επισυνάπτοντας την απόδειξη αγοράς και στοιχεία για το ελάττωμα και την ημερομηνία που παρουσιάστηκε, στη διεύθυνση του σέρβις μας που σας κοινοποιήθηκε. Προς αποφυγή προβλημάτων παραλαβής και πρόσθετων δαπανών, παρακαλούμε να χρησιμοποιήσετε μόνο τη διεύθυνση που σας κοινοποιήθηκε. Σιγουρευτείτε πως η αποστολή δεν έγινε χωρίς πληρωμή των ταχυδρομικών τελών, σαν ογκώδες αντικείμενο, σαν εξπρές, ή με άλλο ειδικό τρόπο. Στείλτε τη συσκευή μαζί με όλα τα αξεσουάρ που σας παραδόθηκαν κατά την αγορά και φροντίστε για ασφαλή συσκευασία.



## Service-Center

### Σέρβις Ελλάδα

Tel.: 801 5000 019

(0,03 EUR/Min.)

E-Mail: grizzly@lidl.gr

**IAN 78960**



## Υποκατάστημα για σέρβις

Παρακαλούμε να λάβετε υπόψη σας πως η ακόλουθη διεύθυνση δεν είναι η διεύθυνση για σέρβις. Επικοινωνήστε πρώτα με το πιο πάνω αναφερόμενο κέντρο εξυπηρέτησης πελατών.

### Houston Service

10-12, Thiatiron Str.

14231 N. Ionia - Athens

## Σέρβις επισκευής

Επισκευές που δεν καλύπτονται από την εγγύηση μπορούν να εκτελεστούν από το υποκατάστημά μας για σέρβις έναντι πληρωμής. Το υποκατάστημα σέρβις θα σας υποβάλει προϋπολογισμό εξόδων.

Μπορούμε να αναλάβουμε την επεξεργασία συσκευών που μας απεστάλησαν καλά συσκευασμένες και με πληρωμένα ταχυδρομικά τέλη.

**Προσοχή:** Παρακαλούμε να στείλετε τη συσκευή σας στο υποκατάστημά μας για σέρβις, καλά καθαρισμένη και με την σχετική υπόδειξη για το ελάττωμα.

Οι συσκευές που στέλνονται χωρίς να έχουν πληρωθεί τα ταχυδρομικά τέλη - με εξπρές, σαν ογκώδη αντικείμενα, ή με άλλο ειδικό τρόπο - δεν θα γίνονται δεκτές.

Την απόρριψη των ελαττωματικών σας συσκευών που μας στέλνετε την αναλαμβάνουμε δωρεάν.

## Inhalt

<b>Einleitung</b> .....	<b>50</b>
<b>Bestimmungsgemäße Verwendung</b> .....	<b>50</b>
<b>Allgemeine Beschreibung</b> .....	<b>51</b>
Lieferumfang.....	51
Funktionsbeschreibung .....	51
Übersicht .....	51
<b>Technische Daten</b> .....	<b>52</b>
<b>Sicherheitshinweise</b> .....	<b>52</b>
Bildzeichen auf dem Gerät.....	52
Bildzeichen in der Anleitung.....	53
Allgemeine Sicherheitshinweise .....	53
<b>Inbetriebnahme</b> .....	<b>55</b>
Aufstellen .....	55
Netzanschluss .....	55
Betrieb.....	55
Hochdruck-/ Niederdruckbetrieb.....	56
Betrieb unterbrechen .....	57
Betrieb beenden .....	57
Verwendung von Reinigungsmitteln ..	57
<b>Reinigung und Wartung</b> .....	<b>58</b>
Reinigung .....	58
Wartung .....	58
<b>Lagerung</b> .....	<b>58</b>
<b>Entsorgung/Umweltschutz</b> .....	<b>58</b>
<b>Fehlersuche</b> .....	<b>59</b>
<b>Ersatzteile</b> .....	<b>59</b>
<b>Garantie</b> .....	<b>60</b>
<b>Reparatur-Service</b> .....	<b>61</b>
<b>Service-Center</b> .....	<b>61</b>
<b>Service-Niederlassung</b> .....	<b>61</b>
<b>Original EG-Konformitäts- erklärung</b> .....	<b>64</b>

## Einleitung



Herzlichen Glückwunsch zum Kauf Ihres neuen Gerätes.

Sie haben sich damit für ein hochwertiges Produkt entschieden. Die Betriebsanleitung ist Bestandteil dieses Produkts. Sie enthält wichtige Hinweise für Sicherheit, Gebrauch und Entsorgung. Machen Sie sich vor der Benutzung des Produkts mit allen Bedien- und Sicherheitshinweisen vertraut. Benutzen Sie das Produkt nur wie beschrieben und für die angegebenen Einsatzbereiche.

Bewahren Sie die Anleitung gut auf und händigen Sie alle Unterlagen bei Weitergabe des Produkts an Dritte mit aus.

## Bestimmungsgemäße Verwendung

Verwenden Sie diesen Hochdruckreiniger ausschließlich für den Privathaushalt:

- zum Reinigen von Maschinen, Fahrzeugen, Bauwerken, Werkzeugen, Fassaden, Terrassen, Gartengeräten usw. mit Hochdruckwasserstrahl.
- mit original Zubehörteilen und Ersatzteilen.
- unter Beachtung der Herstellerangaben des zu reinigenden Objektes.
- Für empfindliche und lackierte Oberflächen (z.B. Autolack) ist die rotierende Waschbürste grundsätzlich nicht geeignet.

## Allgemeine Beschreibung



Die Abbildung der wichtigsten Funktionsteile finden Sie auf der Ausklappseite.

### Lieferumfang

Packen Sie das Gerät aus und überprüfen Sie den Lieferumfang:

- Hochdruckreiniger mit Netzanschlussleitung
- Tragegriff mit 2 Befestigungsschrauben
- Hochdruckschlauch auf Schlauchtrommel
- Halterung für Netzanschlussleitung
- Halter für Spritzpistole
- Schnellanschluss für die Wasserversorgung
- Spritzpistole
- Gabelschlüssel
- Turbo-Schmutzfräse
- Standard-Vario-Düse
- Rotierende Waschbürste
- Düsenreinigungsnadel
- 0,5 l Reinigungsmittel
- Betriebsanleitung

Entsorgen Sie das Verpackungsmaterial ordnungsgemäß.

### Funktionsbeschreibung

Der Hochdruckreiniger reinigt mit Hilfe eines Wasserstrahls, wahlweise im Hochdruck- oder Niederdruckbetrieb.

Bei Bedarf ist er auch mit Zusatz von Reinigungsmitteln zu betreiben.

Die Funktion der Bedienteile entnehmen Sie bitte den nachfolgenden Beschreibungen.

Beachten Sie die Sicherheitshinweise.

## Übersicht

- |          |   |
|----------|---|
| <b>A</b> | 1 Spritzpistole                               |
|          | 2a Tragegriff                                 |
|          | 2b 2 Befestigungsschrauben Tragegriff         |
|          | 3 Hochdruckschlauch auf Schlauchtrommel       |
|          | 4 Kurbel für Schlauchtrommel                  |
|          | 5 Halterung für Netzanschlussleitung          |
|          | 6 Netzanschlussleitung                        |
|          | 7 Räder                                       |
|          | 8 Siebeinsatz                                 |
|          | 9 Wasseranschluss                             |
|          | 10 Ein-/Ausschalter                           |
|          | 11 Halter für Spritzpistole                   |
|          | 12 Hochdruckanschluss Pistolenseite           |
|          | 13 Schnellanschluss für Gartenschlauchadapter |
|          | 14 Öffnung Reinigungsmittelbehälter           |
|          | 15 Reinigungsmittelbehälter                   |
|          | 16 Zubehörhalter                              |
|          | 17 Turbo-Schmutzfräse                         |
|          | 18 Standard-Vario-Düse                        |
|          | 19 Rotierende Waschbürste                     |
|          | 20 Düsenreinigungsnadel                       |
|          | 21 Reinigungsmittel                           |
|          | 22 Gabelschlüssel                             |
| <b>B</b> | 23 Verriegelungsknopf                         |
|          | 24 Einschalthebel                             |

## Technische Daten

### Hochdruckreiniger .... PHD 150 B2

Nenneingangsspannung .... 230V~, 50 Hz  
 Leistungsaufnahme ..... 2100 W  
 Länge Netzanschlussleitung ..... 5 m  
 Gewicht ..... 10,8 kg  
 Schutzklasse ..... □ II  
 Schutzart ..... IPX5  
 Bemessungsdruck/Arbeitsdruck (p) ... 11 MPa  
 Max. zulässiger Druck (p max) .... 15 MPa  
 Max. Zulaufdruck (p in max) ..... 0,8 MPa  
 Max. Zulauftemperatur (T in max)..... 40°C  
 Bemessungsdurchflussmenge (Q) ... 5,5 l/min  
 Max. Bemessungsdurchflussmenge  
 (Q max) ..... 7,5 l/min  
 Schalldruckpegel  
 ( $L_{pA}$ ) ..... 78,2 dB (A);  $K_{pA} = 3,0$  dB (A)  
 Schallleistungspegel, ( $L_{WA}$ )  
 gemessen ... 91,7 dB (A);  $K_{WA} = 3,0$  dB(A)  
 garantiert ..... 98,0 dB (A)  
 Vibration ( $a_n$ ) .... 0,496 m/s<sup>2</sup>;  $K = 1,5$  m/s<sup>2</sup>

Dieses Gerät ist für den Betrieb an einem Stromversorgungsnetz mit einer Systemimpedanz  $Z_{max}$  am Übergabepunkt (Hausanschluss) von maximal 0,277 Ohm vorgesehen.

Der Anwender hat sicherzustellen, dass das Gerät nur an einem Stromversorgungsnetz betrieben wird, das diese Anforderung erfüllt.

Wenn nötig, kann die Systemimpedanz beim lokalen Energieversorgungsunternehmen erfragt werden.

Technische und optische Veränderungen können im Zuge der Weiterentwicklung ohne Ankündigung vorgenommen werden. Alle Maße, Hinweise und Angaben dieser Betriebsanleitung sind deshalb ohne Gewähr. Rechtsansprüche, die aufgrund der Betriebsanleitung gestellt werden, können daher nicht geltend gemacht werden.

## Sicherheitshinweise

Dieser Abschnitt behandelt die grundlegenden Sicherheitsvorschriften bei der Arbeit mit dem Hochdruckreiniger.

### Bildzeichen auf dem Gerät



Achtung!



Machen Sie sich vor der Arbeit mit allen Bedienelementen gut vertraut, insbesondere mit Funktionen und Wirkungsweisen. Fragen Sie ggf. eine Fachkraft.

Lesen und beachten Sie die zum Gerät gehörende Betriebsanleitung!



Achtung! Ziehen Sie bei Beschädigung oder Durchschneiden der Netzanschlussleitung sofort den Stecker aus der Steckdose. Ziehen Sie auch den Stecker aus der Steckdose beim Anschließen an die Wasserzufuhr oder beim Versuch Undichtigkeiten zu beseitigen.



Gerät, das nicht zum Anschluss an die Trinkwasserversorgungsanlage geeignet ist.



Schutzklasse II



Elektrogeräte gehören nicht in den Hausmüll.



Hochdruckreiniger können bei unsachgemäßem Gebrauch gefährlich sein. Der Strahl darf nicht auf Personen, Tiere, aktive elektrische Ausrüstung oder das Gerät selbst gerichtet werden.



Betreiben Sie das Gerät nur in stehender, niemals in liegender Position.

## Bildzeichen in der Anleitung



**Gefahrenzeichen (anstelle des Ausrufungszeichens kann die Gefahr erläutert sein) mit Angaben zur Verhütung von Personen- oder Sachschäden.**



Gebotszeichen (anstelle des Ausrufungszeichens kann das Gebot erläutert sein) mit Angaben zur Verhütung von Schäden.



Hinweiszeichen mit Informationen zum besseren Umgang mit dem Gerät.



Hochdruckreiniger können bei unsachgemäßem Gebrauch gefährlich sein. Der Strahl darf nicht auf Personen, Tiere, aktive elektrische Ausrüstung oder das Gerät selbst gerichtet werden.

## Allgemeine Sicherheitshinweise

- Dieses Gerät ist nicht dafür bestimmt, durch Personen (einschließlich Kinder) mit eingeschränkten physischen, sensorischen oder geistigen Fähigkeiten oder mangels Erfahrung und/oder mangels Wissen benutzt zu werden; es sei denn, sie werden durch eine für ihre Sicherheit zuständige Person beaufsichtigt oder erhalten von ihr Anweisungen, wie das Gerät zu benutzen ist.
- Kinder sollen beaufsichtigt werden, um sicherzustellen, dass sie nicht mit dem Gerät spielen.
- Personen, die mit der Betriebsanleitung nicht vertraut sind, dürfen das Gerät nicht benutzen. Das Bedienen des Gerätes ist Personen unter 16 Jahren nicht gestattet.
- Hochdruckreiniger dürfen nicht von Kindern oder nicht unterwiesenen Personen betrieben werden.

- Benutzen Sie das Gerät nur stehend und auf einem ebenen und stabilen Untergrund.
- Richten Sie den Strahl nicht auf sich selbst oder andere, um Kleidung oder Schuhwerk zu reinigen.
- Zum Schutz vor zurückspritzendem Wasser oder Schmutz geeignete Schutzkleidung und Schutzbrille tragen.
- Verwenden Sie das Gerät nicht, wenn sich andere Personen in Reichweite befinden, es sei denn, sie tragen Schutzkleidung.
- Ergreifen Sie geeignete Maßnahmen, um Kinder vom laufenden Gerät fernzuhalten.
- Benutzen Sie das Gerät nicht in der Nähe von entzündbaren Flüssigkeiten oder Gasen. Bei Nichtbeachtung besteht Brand- oder Explosionsgefahr.
- Versprühen Sie keine brennbaren Flüssigkeiten. Es besteht Explosionsgefahr.
- Wenn Sie mit Reinigungsmittel in Kontakt kommen, spülen Sie mit reichlich reinem Wasser.
- Bewahren Sie das Gerät an einem trockenen Ort und außerhalb der Reichweite von Kindern auf.



**Vorsicht! So vermeiden Sie Geräteschäden und eventuell daraus resultierende Personenschäden:**

- Arbeiten Sie nicht mit einem beschädigten, unvollständigen oder ohne die Zustimmung des Herstellers umgebauten

## Arbeiten mit dem Gerät



**Vorsicht! So vermeiden Sie Unfälle und Verletzungen:**

Gerät. Lassen Sie vor Inbetriebnahme durch einen Fachmann prüfen, dass die geforderten elektrischen Schutzmaßnahmen vorhanden sind.

- Nehmen Sie das Gerät nicht in Betrieb, wenn die Netzanschlussleitung, der Wasserzulauf oder andere wichtige Teile wie der Hochdruckschlauch oder die Spritzpistole beschädigt bzw. undicht sind.
- Schützen Sie das Gerät vor Frost und Trockenlaufen.
- Hochdruckschläuche, Armaturen und Kupplungen sind wichtig für die Maschinensicherheit. Verwenden Sie nur vom Hersteller empfohlene Hochdruckschläuche, Armaturen und Kupplungen.
- Verwenden Sie zur Sicherstellung der Maschinensicherheit nur Original-Ersatzteile vom Hersteller oder vom Hersteller freigegebene Ersatzteile.
- Das Öffnen des Gerätes ist nur von einer autorisierten Elektrofachkraft auszuführen. Wenden Sie sich im Reparaturfall immer an unser Service-Center.

### Elektrische Sicherheit:



#### **Vorsicht: So vermeiden Sie Unfälle und Verletzungen durch elektrischen Schlag:**

- Bei Verwendung einer Verlängerungsleitung müssen Stecker und Kupplung wasserdicht sein.



Ungeeignete Verlängerungsleitungen können gefährlich sein. Es besteht die Gefahr von Personenschäden durch elektrischen Schlag.

- Schützen Sie die elektrischen Steckverbindungen vor Nässe.
- Bei Überschwemmungsgefahr die Steckverbindungen im überflutungssicheren Bereich anbringen.

chere Bereich anbringen.

- Achten Sie darauf, dass die Netzspannung mit den Angaben des Typenschildes übereinstimmt.
- Der Netzanschluss muss von einem erfahrenen Elektriker vorgenommen werden und die Anforderungen von IEC 60364-1 erfüllen.
- Schließen Sie das Gerät nur an eine Steckdose mit Fehlerstrom-Schutzeinrichtung (FI-Schalter) mit einem Auslösestrom von nicht mehr als 30 mA an.
- Prüfen Sie vor jedem Gebrauch Gerät, Netzanschlussleitung und Stecker auf Beschädigungen.
- Wenn die Anschlussleitung dieses Gerätes beschädigt wird, muss sie durch den Hersteller oder seinen Kundendienst oder eine ähnlich qualifizierte Person ersetzt werden, um Gefährdungen zu vermeiden.
- Benutzen Sie die Netzanschlussleitung nicht, um den Stecker aus der Steckdose zu ziehen. Schützen Sie die Netzanschlussleitung vor Hitze, Öl und scharfen Kanten.
- Tragen oder befestigen Sie das Gerät nicht an der Netzanschlussleitung.
- Verwenden Sie nur Verlängerungskabel, die spritzwassergeschützt und für den Gebrauch im Freien bestimmt sind. Rollen Sie eine Kabeltrommel vor Gebrauch immer ganz ab. Überprüfen Sie das Kabel auf Schäden.
- Ziehen Sie vor allen Arbeiten am Gerät, in Arbeitspausen und bei Nichtgebrauch den Netzstecker aus der Steckdose.
- Netzanschlussleitungen dürfen keinen geringeren Querschnitt besitzen als  $2 \times 2,5 \text{ mm}^2$ .
- Tragen Sie zum Schutz gegen elektrischen Schlag festes Schuhwerk.
- Betreiben Sie zum Schutz gegen elektrischen Schlag das Gerät ausschließlich in aufrechter, stehender Position.

## Inbetriebnahme



Gemäß gültiger Vorschriften darf der Hochdruckreiniger nie ohne Systemtrenner am Trinkwasser-Netz betrieben werden. Es ist ein geeigneter Systemtrenner gemäß EN 12729 Typ BA zu verwenden.

Wasser, das durch einen Systemtrenner geflossen ist, wird als nicht trinkbar eingestuft. Ein Systemtrenner ist im Fachhandel erhältlich.

- Verwenden Sie einen handelsüblichen Gartenschlauch für den Wasserzulauf und achten Sie auf eine ausreichende Länge.
- Benutzen Sie das Gerät an einem Hauswasseranschluss oder einer Wasserquelle mit wenigstens 450l/h Förderleistung.

## Aufstellen

1. Schieben Sie den Tragegriff (2a) in die Vierkantrohre des Tragegestells. Der Tragegriff (2a) rastet hörbar ein. Fixieren Sie den Tragegriff (2a) mit den beiden beiliegenden Schrauben (2b) von der Rückseite.
2. Schieben Sie die Halterung für die Netzanschlussleitung (5) und den Halter für die Spritzpistole (11) auf die Führungen am Gerätegehäuse auf.
3. Verschrauben Sie den Hochdruckanschluss Pistolenseite (12) mit der Spritzpistole (1). Benutzen Sie den beiliegenden Gabelschlüssel (22).
4. Schließen Sie den Zuleitungsschlauch an die Wasserversorgung an und lassen Sie Wasser am anderen Ende des Zuleitungsschlauches blasenfrei austreten, um den Zuleitungsschlauch zu entlüften. Schließen Sie den Wasserhahn.
5. Verbinden Sie den Zuleitungsschlauch mit Hilfe des Schnellanschlusses für Gartenschlauchadapter (13) mit dem

Wasseranschluss (9) am Gerät.

Verwenden Sie immer den Siebeinsatz (8) und reinigen Sie diesen bei Bedarf.

6. Verbinden Sie durch Einstecken und Eindrehen die Turbo-Schmutzfräse (17), die Standard-Vario-Düse (18) oder die rotierende Waschbürste (19) mit der Spritzpistole (1) (Bajonettverschluss).
7. Ein Wechsel der Düsen (17/18) oder der rotierenden Waschbürste (19) erfolgt durch Eindrücken und Drehen in die entgegengesetzte Richtung.

## Netzanschluss

Der von Ihnen erworbene Hochdruckreiniger ist bereits mit einem Netzstecker versehen. Das Gerät ist bestimmt für den Anschluss an eine Schutzkontaktsteckdose mit Fehlerstrom-Schutzeinrichtung (FI-Schalter) mit 230 V ~ 50Hz.



Nehmen Sie das Gerät erst nach Beachtung aller vorhergehenden Punkte in Betrieb.

1. Stellen Sie sicher, dass der Hochdruckreiniger am Ein-/Ausschalter (10) ausgeschaltet ist.
2. Stecken Sie den Netzstecker in die Steckdose.

## Betrieb



**Beachten Sie die Rückstoßkraft des austretenden Wasserstrahles. Sorgen Sie für einen sicheren Stand und halten Sie die Spritzpistole (1) gut fest. Sie können sonst sich oder andere Personen verletzen.**



Betreiben Sie das Gerät nicht mit geschlossenem Wasserhahn. Ein Trockenlauf führt zu einer Beschädigung des Gerätes.

1. Öffnen Sie den Wasserhahn vollständig.
2. Schalten Sie das Gerät am Ein-/Aus-schalter (10) ein. Schalten Sie das Gerät immer erst dann ein, wenn Sie alle Wasserleitungen angeschlossen haben und diese dicht sind.

Der Motor schaltet sich ein, bis der notwendige Druck aufgebaut ist. Nach Druckaufbau schaltet sich der Motor ab.

3. Drücken Sie den Einschalthebel (24) der Spritzpistole (1). Die Düse arbeitet mit Druck und der Motor schaltet sich wieder ein.

Das Loslassen des Einschalthebels (24) bewirkt ein Abschalten des Gerätes. Der Hochdruck im System bleibt erhalten.

- Die Turbo-Schmutzfräse (17) ist mit ihrem rotierenden Wasserstrahl besonders zum Arbeiten mit geringem Wasserverbrauch geeignet.
- Die Standard-Vario-Düse (18) eignet sich mit ihrem Flachstrahl besonders für Flächenreinigungen.

Durch Drehen der Düsenspitze nach links können Sie die Breite des Strahls verringern. Durch Drehen der Düsenspitze nach rechts können Sie die Breite des Strahls vergrößern.



**Bei Undichtigkeiten im Wassersystem schalten Sie das Gerät sofort am Ein-/Aus-schalter (10) aus und trennen Sie das Gerät an der Netzanschlussleitung (6) vom Netz. Es besteht Gefahr durch elektrischen Schlag! Beginnen Sie erneut mit dem Herstellen der Wasseranschlüsse (siehe „Inbetriebnahme-Aufstellen“ ab Punkt 4.).**



## **Wenn sich noch Luft im Gerät befindet, bitte wie folgt vorgehen:**

### **Zuleitungsschlauch entlüften:**

1. Entfernen Sie den Schnellanschluss für Gartenschlauchadapter (13) am Wasseranschluss (9) und öffnen Sie den Wasserhahn, bis Wasser blasenfrei austritt.
2. Schließen Sie den Wasserhahn.
3. Verbinden Sie den Zuleitungsschlauch mit Hilfe des Schnellanschlusses für Gartenschlauchadapter (13) mit dem Wasseranschluss (9) am Gerät.
4. Öffnen Sie den Wasserhahn vollständig.

### **Gerät entlüften:**

5. Schalten Sie das Gerät am Ein-/Aus-schalter (10) ein, bis Druck aufgebaut ist.
6. Schalten Sie das Gerät am Ein-/Aus-schalter (10) aus.
7. Drücken Sie den Einschalthebel (24) der Spritzpistole (1), bis sich der Druck abgebaut hat.
8. Wiederholen Sie den Vorgang 5. bis 7. bitte einige Male, bis sich keine Luft mehr im Gerät befindet.

## **Hochdruck-/ Niederdruckbetrieb**

Die Standard-Vario-Düse (18) ist für den wahlweisen Betrieb mit Hochdruck und Niederdruck ausgelegt.

In der Standardeinstellung arbeitet die Standard-Vario-Düse mit Hochdruck. Sie können die Düsenspitze nach vorne schieben und so auf den Niederdruckbetrieb wechseln.

In diesem Betriebsmodus (Niederdruck) wird automatisch aus dem eingebauten Behälter Reinigungsmittel angesaugt (siehe „Verwendung von Reinigungsmittel“).

Ein Wechsel in den Hochdruckmodus erfolgt durch Einschieben der Düsenspitze.



- B**
- Sie können den Einschalthebel (24) der Spritzpistole (1) durch Drücken des Verriegelungsknopfes (23) wahlweise verriegeln oder entriegeln.  
**Durch das Verriegeln des Einschalthebels verhindern Sie einen unbeabsichtigten Start des Gerätes.**



verriegelt



offen

**Betrieb unterbrechen**

- Lassen Sie den Einschalthebel (24) der Spritzpistole (1) los.
- Schalten Sie bei längeren Arbeitspausen den Ein-/Ausschalter (10) aus.



**Sollte das Gerät umfallen, schalten Sie das Gerät sofort am Ein-/Ausschalter (10) aus und trennen Sie das Gerät an der Netzanschlussleitung (6) vom Netz. Es besteht Gefahr durch elektrischen Schlag! Bringen Sie erst jetzt das Gerät wieder in aufrechte, stehende Position. Warten Sie zu Ihrer eigenen Sicherheit ca. fünf Minuten, bis Sie den elektrischen Anschluss wieder herstellen.**

**Betrieb beenden**

1. Nach Arbeiten mit Reinigungsmitteln das System mit klarem Wasser spülen, indem Sie klares Wasser ohne Niederdruckbetrieb versprühen.
2. Lassen Sie den Einschalthebel (24) der Spritzpistole (1) los.
3. Schalten Sie das Gerät am Ein-/Ausschalter (10) aus. Ziehen Sie den Netzstecker.

4. Schließen Sie den Wasserhahn.
5. Trennen Sie den Hochdruckreiniger von der Wasserversorgung.
6. Drücken Sie den Einschalthebel (24) der Spritzpistole (1), um den vorhandenen Druck im System abzubauen.

**Verwendung von Reinigungsmitteln**

Dieses Gerät wurde für den Einsatz mit einem neutralen Reinigungsmittel auf der Basis biologisch abbaubarer anionischer Tenside entwickelt. Die Verwendung anderer Reinigungsmittel oder chemischer Substanzen kann die Sicherheit des Gerätes beeinträchtigen und zu Beschädigungen führen. Derartige Schäden am Gerät unterliegen nicht der Garantie.

**Reinigungsmittel auffüllen/entleeren:**

- Zur Verwendung von Reinigungsmittel, muss sich Reinigungsmittel im Reinigungsmittelbehälter (15) befinden.
- Zum Entfernen des Reinigungsmittelbehälters (15) greifen Sie den Behälter seitlich und schieben ihn nach oben. Jetzt können Sie den Reinigungsmittelbehälter aus seiner unteren und seitlichen Führung vom Hochdruckreiniger wegnehmen. Entfernen Sie dabei an der Öffnung des Reinigungsmittelbehälters (14) den Ansaugschlauch mit der Verschlusskappe. Diese verbleiben am Hochdruckreiniger.
- Um den Reinigungsmittelbehälter (15) wieder einzusetzen, verfahren Sie in umgekehrter Reihenfolge.

**Arbeitshinweise:**

- Benutzen Sie die Standard-Vario-Düse (18) im Niederdruckbetrieb und das Reinigungsmittel wird automatisch angesaugt.
- Die rotierende Waschbürste (19) arbeitet grundsätzlich im Niederdruck-

betrieb und saugt so immer Reinigungsmittel an.

- Möchten Sie die rotierende Waschbürste (19) ohne Reinigungsmittel benutzen, müssen Sie den Reinigungsmittelbehälter (15) entfernen.

## Reinigung und Wartung



Ziehen Sie vor allen Arbeiten an dem Gerät den Netzstecker. Dazu gehört auch das Anschließen an die Wasserzufuhr oder der Versuch Undichtigkeiten zu beseitigen. Es besteht die Gefahr eines Stromschlages oder Verletzungsgefahr durch bewegliche Teile.

## Reinigung



**Spritzen Sie das Gerät nicht mit Wasser ab und reinigen Sie es nicht unter fließendem Wasser. Es besteht Gefahr von Stromschlag und das Gerät könnte beschädigt werden.**

**Halten Sie das Gerät stets sauber. Verwenden Sie keine Reinigungs- bzw. Lösungsmittel.**

- Halten Sie die Lüftungsschlitze sauber und frei.
- Reinigen Sie das Gerät mit einer weichen Bürste oder mit einem feuchten Tuch.
- Sollte eine der Düsen (17/18) verstopft sein, können Sie mit der Düsenreinigungsnadel (20) den Fremdkörper in der Düse entfernen.

## Wartung

Der Hochdruckreiniger ist wartungsfrei.



**Lassen Sie Arbeiten, die nicht in dieser Anleitung beschrieben sind, von unserem Service-Center durchführen. Verwenden Sie nur Originalteile. Es besteht Verletzungsgefahr.**

## Lagerung

- Entleeren Sie den Hochdruckreiniger vollständig von Wasser. Trennen Sie hierzu das Gerät von der Wasserversorgung. Schalten Sie den Hochdruckreiniger am Ein-/Ausschalter (10) für maximal 1 Minute ein, bis kein Wasser mehr an der Spritzpistole (1) oder an den Aufsätzen (17/18/19) austritt. Schalten Sie das Gerät aus.
- Der Hochdruckreiniger und das Zubehör werden von Frost zerstört, wenn sie nicht vollständig von Wasser entleert sind.
- Bewahren Sie das Gerät und das Zubehör in einem frostsicheren Raum auf.

## Entsorgung/ Umweltschutz

Führen Sie Gerät, Zubehör und Verpackung einer umweltgerechten Wiederverwertung zu.



Geräte gehören nicht in den Hausmüll.

Geben Sie das Gerät an einer Verwertungsstelle ab. Die verwendeten Kunststoff- und Metallteile können sortenrein getrennt und so einer Wiederverwertung zugeführt werden. Fragen Sie hierzu unser Service-Center.

## Fehlersuche

Problem	Mögliche Ursache	Fehlerbehebung
Gerät läuft nicht	Ein-/Ausschalter (10) ausgeschaltet	Ein-/Ausschalterstellung überprüfen
	Beschädigte Netzanschlussleitung (6)	Schalten Sie das Gerät aus und trennen Sie es vom Netz. Netzanschlussleitung (6) auf Beschädigung kontrollieren. Gegebenenfalls Netzanschlussleitung (6) von einer autorisierten Fachkraft ersetzen lassen.
	Fehlerhafte Spannungsversorgung	Kontrollieren Sie die elektrische Anlage auf Übereinstimmung mit den Angaben auf dem Typenschild
Gerät hat keinen Druck	Luftfeinschlüsse im Hochdruckreiniger	Schalten Sie das Gerät mit Spritzpistole und ohne Düse an, bis blasenfreies Wasser austritt
	Leitungsdruckabfall	Kontrollieren Sie die Wasserversorgung
Starke Druckschwankungen	Turbo-Schmutzfräse (17) verschmutzt	Spülen Sie die Turbo-Schmutzfräse (17) mit Wasser. Reinigen Sie bei Bedarf die Düsenbohrung mit einer Nadel
Undichtigkeiten im Wasseresystem	Anschlüsse nicht richtig montiert	Schalten Sie das Gerät aus und trennen Sie es vom Netz. Schließen Sie das Gerät erneut an die Wasserleitungen an (s. „Inbetriebnahme-Aufstellen“)
	Wasseranschluss (9) undicht	Schalten Sie das Gerät aus und trennen Sie es vom Netz. Wechseln Sie den Wasseranschluss (9) inkl. Dichtungsring aus (s. „Ersatzteile“)

## Ersatzteile

Wenden Sie sich zum Nachkauf von Ersatzteilen an die angegebene Service-Adresse. Geben Sie bitte bei Ihrer Bestellung den Maschinentyp und die Artikel-Nummer des Ersatzteiles an.

<b>A</b>	<b>Pos.</b>	<b>Bezeichnung</b> .....	<b>Artikel-Nr.</b>
	1	Spritzpistole.....	91097399
	3	Hochdruckschlauch.....	91097400
	13	Schnellanschluss für Gartenschlauchadapter.....	91097401
	17	Turbo-Schmutzfräse.....	91097403
	18	Standard-Vario-Düse.....	91097404
	19	Rotierende Waschbürste.....	91097405
	9	Wasseranschluss inkl. Dichtungsring.....	91097408

Zubehör kann online unter [www.grizzly.biz/shop/](http://www.grizzly.biz/shop/) bestellt werden!

## Garantie

Sehr geehrte Kundin, sehr geehrter Kunde, Sie erhalten auf dieses Gerät 3 Jahre Garantie ab Kaufdatum.

Im Falle von Mängeln dieses Produkts stehen Ihnen gegen den Verkäufer des Produkts gesetzliche Rechte zu. Diese gesetzlichen Rechte werden durch unsere im Folgenden dargestellte Garantie nicht eingeschränkt.

### Garantiebedingungen

Die Garantiefrist beginnt mit dem Kaufdatum. Bitte bewahren Sie den Original Kassenbon gut auf. Diese Unterlage wird als Nachweis für den Kauf benötigt.

Tritt innerhalb von drei Jahren ab dem Kaufdatum dieses Produkts ein Material- oder Fabrikationsfehler auf, wird das Produkt von uns – nach unserer Wahl – für Sie kostenlos repariert oder ersetzt. Diese Garantieleistung setzt voraus, dass innerhalb der Drei-Jahres-Frist das defekte Gerät und der Kaufbeleg (Kassenbon) vorgelegt und schriftlich kurz beschrieben wird, worin der Mangel besteht und wann er aufgetreten ist.

Wenn der Defekt von unserer Garantie gedeckt ist, erhalten Sie das reparierte oder ein neues Produkt zurück. Mit Reparatur oder Austausch des Produkts beginnt kein neuer Garantiezeitraum.

### Garantiezeit und gesetzliche Mängelansprüche

Die Garantiezeit wird durch die Gewährleistung nicht verlängert. Dies gilt auch für ersetzte und reparierte Teile. Eventuell schon beim Kauf vorhandene Schäden und Mängel müssen sofort nach dem Auspacken gemeldet werden. Nach Ablauf der Garantiezeit anfallende Reparaturen sind kostenpflichtig.

### Garantieumfang

Das Gerät wurde nach strengen Qualitätsrichtlinien sorgfältig produziert und vor Anlieferung gewissenhaft geprüft.

Die Garantieleistung gilt für Material- oder Fabrikationsfehler. Diese Garantie erstreckt sich nicht auf Produktteile, die normaler Abnutzung ausgesetzt sind und daher als Verschleißteile angesehen werden können (z.B. Filter oder Aufsätze) oder für Beschädigungen an zerbrechlichen Teilen (z.B. Schalter, Akkus oder die aus Glas gefertigt sind). Diese Garantie verfällt, wenn das Produkt beschädigt, nicht sachgemäß benutzt oder nicht gewartet wurde. Für eine sachgemäße Benutzung des Produkts sind alle in der Betriebsanleitung aufgeführten Anweisungen genau einzuhalten. Verwendungszwecke und Handlungen, von denen in der Betriebsanleitung abgeraten oder vor denen gewarnt wird, sind unbedingt zu vermeiden. Das Produkt ist lediglich für den privaten und nicht für den gewerblichen Gebrauch bestimmt. Bei missbräuchlicher und unsachgemäßer Behandlung, Gewaltanwendung und bei Eingriffen, die nicht von unserer autorisierten Service-Niederlassung vorgenommen wurden, erlischt die Garantie.

### Abwicklung im Garantiefall

Um eine schnelle Bearbeitung Ihres Anliegens zu gewährleisten, folgen Sie bitte den folgenden Hinweisen:

- Bitte halten Sie für alle Anfragen den Kassenbon und die Artikelnummer (z.B. IAN 12345) als Nachweis für den Kauf bereit.
- Die Artikelnummer entnehmen Sie bitte dem Typenschild, einer Gravur, auf dem Titelblatt Ihrer Anleitung (unten links) oder als Aufkleber auf der Rück- oder Unterseite.
- Sollten Funktionsfehler oder sonstige Mängel auftreten kontaktieren Sie zunächst die nachfolgend benannte

Serviceabteilung **telefonisch** oder per **E-Mail**. Sie erhalten dann weitere Informationen über die Abwicklung Ihrer Reklamation.

- Ein als defekt erfasstes Produkt können Sie, nach Rücksprache mit unserem Kundenservice, unter Beifügung des Kaufbelegs (Kassenbons) und der Angabe, worin der Mangel besteht und wann er aufgetreten ist, für Sie portofrei an die Ihnen mitgeteilte Service-Anschrift übersenden. Um Annehmeprobleme und Zusatzkosten zu vermeiden, benutzen Sie unbedingt nur die Adresse, die Ihnen mitgeteilt wird. Stellen Sie sicher, dass der Versand nicht unfrei, per Sperrgut, Express oder sonstiger Sonderfracht erfolgt. Senden Sie das Gerät bitte inkl. aller beim Kauf mitgelieferten Zubehörteile ein und sorgen Sie für eine ausreichend sichere Transportverpackung.

## Reparatur-Service

Sie können Reparaturen, die nicht der Garantie unterliegen, gegen Berechnung von unserer Service-Niederlassung durchführen lassen. Sie erstellt Ihnen gerne einen Kostenvoranschlag.

Wir können nur Geräte bearbeiten, die ausreichend verpackt und frankiert eingeschickt wurden.

**Achtung:** Bitte senden Sie Ihr Gerät gereinigt und mit Hinweis auf den Defekt an unsere Service-Niederlassung.

Unfrei - per Sperrgut, Express oder mit sonstiger Sonderfracht - eingeschickte Geräte werden nicht angenommen.

Die Entsorgung Ihrer defekten eingesendeten Geräte führen wir kostenlos durch.



## Service-Center



### Service Deutschland

Tel.: 01805772033  
(0,14 EUR/Min. aus dem dt. Festnetz,  
Mobilfunk max. 0,42 EUR/Min.)  
E-Mail: grizzly@lidl.de  
**IAN 78960**



### Service Österreich

Tel.: 0820 201 222  
(0,15 EUR/Min.)  
E-Mail: grizzly@lidl.at  
**IAN 78960**



### Service Schweiz

Tel.: 0842 665566  
(0,08 CHF/Min.,  
Mobilfunk max. 0,40 CHF/Min.)  
E-Mail: grizzly@lidl.ch  
**IAN 78960**



## Service-Niederlassung

Bitte beachten Sie, dass die folgende Anschrift keine Serviceanschrift ist. Kontaktieren Sie zunächst das oben genannte Service-Center.



### Grizzly Gartengeräte GmbH & CO KG

Kundenservice  
Georgenhäuser Str. 1  
64409 Messel  
Homepage: [www.grizzly.biz](http://www.grizzly.biz)







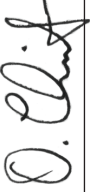

### A.S.A. Marina AG

Postfach Nr. 406  
6906 Lugano Cassarate



<p><b>(GB)</b></p> <p><b>Translation of the original EC declaration of conformity</b></p> <p>We hereby confirm that the <b>Pressure Washer Design Series PHD 150 B2</b> Serial number 201210000001-201210217887 conforms with the following applicable relevant version of the EU guidelines</p>	<p><b>(HR)</b></p> <p><b>Prijelave originalne CE Izjave o podudarnosti</b></p> <p>Ovime potvrđujemo da <b>Visokotlačni uređaj za čišćenje PHD 150 B2</b> Serijski broj 201210000001-201210217887 odgovara slijedećim odgovarajućim direktivama EU-a u njihovoj valjanoj verziji:</p>	<p><b>(RO)</b></p> <p><b>Traducerea Declarației Originale de Conformitate CE</b></p> <p>Prin prezenta confirmăm, că <b>Aparat de curățire cu înaltă presiune PHD 150 B2</b> Numărul serial 201210000001-201210217887 corespunde următoarelor prevederi UE relevante, în ultima lor variantă valabilă:</p>
<p><b>2004/108/EC • 2000/14/EC • 2006/42/EC • 2005/88/EC • 2011/65/EU</b></p>		
<p>In order to guarantee consistency, the following harmonised standards as well as national standards and stipulations have been applied:</p>	<p>Za jamčenje sukladnosti primijenjene su sljedeće usklađene norme kao i nacionalne norme i odredbe:</p>	<p>Pentru a garanta conformitatea, au fost aplicate următoarele norme armonizate, norme naționale și prevederi:</p>
<p><b>EN 55014-1:2006/A2:2011 • EN 55014-2:A2:2008 • EN 61000-3-2:2009 • EN 61000-3-1:2000</b></p>		
<p>We additionally confirm the following in accordance with the 2000/14/EC emissions guideline: Sound power level Guaranteed: 98,0 dB(A) Measured: 91,7 dB(A) Compliance evaluation process carried out in accordance with Appendix V, 2000/14/EC</p>	<p>Dodatno se potvrđuje smjernica o emisiji buke 2000/14/EC: Razina snage zvuka Zajamčeni: 98 dB(A) Izmjereni: 91,7 dB(A) Primijenjeni postupak ocjene sukladnosti u skladu s aneksom V / 2000/14/EC</p>	<p>În plus, conform Directivei privind emisiile sonore 2000/14/CE, se confirmă: Nivelul de intensitate acustică: garantat: 98 dB(A); măsurat: 91,7 dB(A) Proces aplicat de evaluare a conformității, conform Anexei V / 2000/14/CE</p>
<p>Grizzly Gartengeräte GmbH &amp; Co. KG Am Gewerbepark 2 64823 Groß-Umstadt 20. 12.2012</p> <p style="text-align: center;"><b>CE</b></p> <p style="text-align: right;">         Oliver Christ        Documentation Representative; Opunomoćenik za dokumentaciju;        Persoană autorizată cu elaborarea documentației     </p>		

   <p>Hiermit bestätigen wir, dass der  <b>Hochdruckreiniger Baureihe PHD 150 B2</b>          Seriennummern 201210000001-201210210217887</p>	 <p><b>Μετάφραση της πρωτότυπης Δήλωσης συμμόρφωσης CE</b></p>
<p>folgenden einschlägigen EU-Richtlinien in ihrer jeweils gültigen Fassung entspricht:</p>	<p>Με το παρόν δηλώνουμε ότι το είδος κατασκευής της <b>συσκευή καθαρισμού υψηλής πίεσης PHD 150 B2</b> Αριθμός σειράς 201210000001-201210217887 ανταποκρίνεται στις ακόλουθες σχετικές οδηγίες της ΕΕ στην εκάστοτε ισχύουσα έκδοση:</p>
<p><b>2004/108/EC • 2000/14/EC • 2006/42/EC • 2005/88/EC • 2011/65/EU</b></p>	
<p>Um die Übereinstimmung zu gewährleisten, wurden folgende harmonisierte Normen sowie nationale Normen und Bestimmungen angewendet:</p> <p><b>EN 55014-1:2006/A2:2011 • EN 55014-2:A2:2008 • EN 60335-1/A13:2008 • EN 60335-2-79:2009 • EN 62233:2008</b></p> <p><b>EN 55014-1:2006/A2:2011 • EN 55014-2:A2:2008 • EN 61000-3-2:2006/A2:2009 • EN 61000-3-11:2000</b></p>	<p>Για να εξασφαλιστεί η συμβατικότητα, εφαρμόστηκαν οι παρακάτω εναρμονισμένες προδιαγραφές καθώς και εθνικές προδιαγραφές και κανονισμοί:</p>
<p>Συμπληρωματικά βεβαιώνεται σύμφωνα με την Οδηγία για την εκπομπή θορύβων 2000/14/CE:</p> <p>Εγγυημένη στάθμη ακουστικής ισχύος: 98 dB(A)          Μετρημένη στάθμη ακουστικής ισχύος: 91,7 dB(A)          Η διαδικασία που εφαρμόστηκε για την εκτίμηση της συμβατικότητας ανταποκρίνεται στο σχετικό σημείο του Παραρτήματος V / 2000/14/CE:</p> <div style="text-align: right; margin-top: 20px;">   <hr style="width: 100px; margin-left: auto; margin-right: 0;"/> <p>Oliver Christ              Dokumentationsbevollmächtigter,              υπεύθυνος τεκμηρίωσης</p> </div> <div style="text-align: center; margin-top: 20px;">  </div> <p>Grizzly Gartengeräte GmbH &amp; Co. KG          Am Gewerbepark 2          64823 Groß-Umstadt 20.12.2012</p>	





**GRIZZLY GARTENGERÄTE GMBH & CO. KG**

Am Gewerbepark 2  
D-64823 Groß-Umstadt

Last Information Update · Stanje informacija · Versiunea  
informațiilor · Εκδόση των πληροφοριών · Stand der Informationen:  
09/2012 · Ident.-No.: 75040138092012-HR/RO/GR

---

IAN 78960

HR

RO

GR