

3-IN-1 GAS SOLDERING IRON SET

WWS-GLK9-Y02

GB IE NI

3-IN-1 GAS SOLDERING IRON SET

Operation and Safety Notes

IAN 373546_2104

GB IE NI

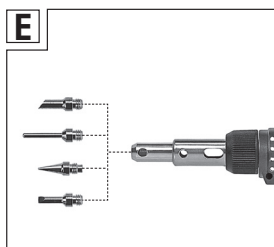
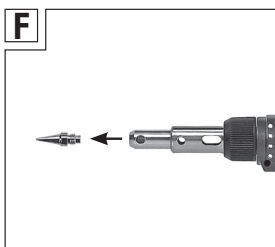
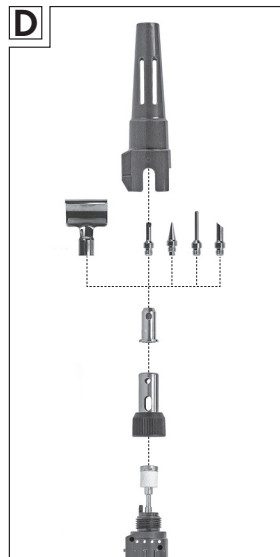
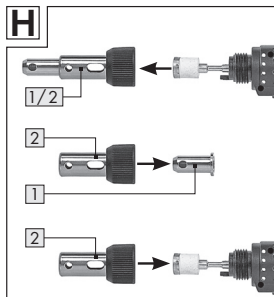
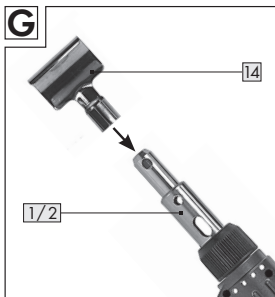
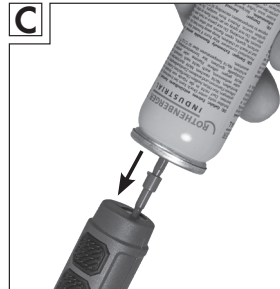
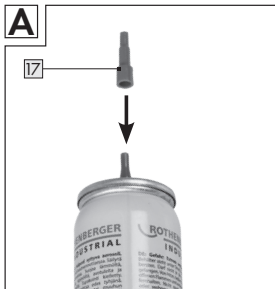
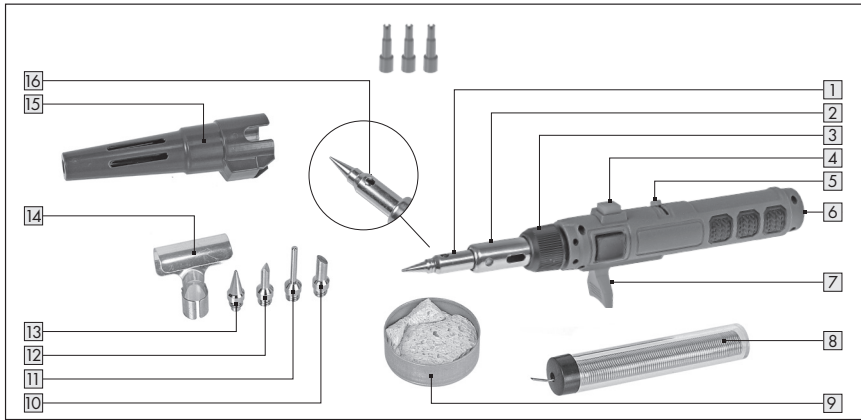

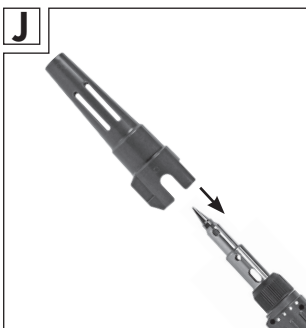
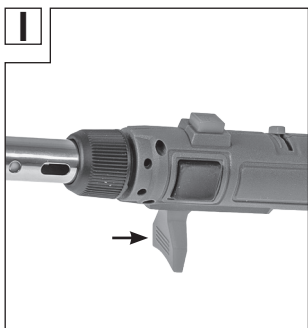









Table of contents

Symbols used.....	5
Introduction	5
Safety instructions.....	6
Intended use	8
Technical specifications	8
Pack contents.....	8
Description of the parts	9
Technical data.....	9
Before using the tool	10
Check the gas soldering iron and scope of delivery.....	10
Filling the gas tank (Figure A-C).....	10
Operation/use.....	11
Assembly of attachments(Figure D).....	11
Use as soldering iron (Figure E).....	11
Use as hot air gun (Figure F).....	12
Use as blowing torch (Figure H).....	12
Igniting and extinguishing the flame.....	13
Shutting down the product safely (Figure I).....	14
Protective cap (Figure J).....	14
Storage conditions.....	14
Cleaning and maintenance.....	14
Troubleshooting.....	15
Disposal.....	16
Instructions for disposal of the gas cartridge.....	16
Warranty.....	16

Important!

Read these instructions carefully so as to familiarise yourself with the appliance before using it. Keep these instructions safely for future reference. In case the user changes, the operating instructions must also be passed on to the new user.

Symbols used

	Follow the warnings and safety instructions!
	Read the operating manual
	Wear eye protection
	Danger: Highly inflammable aerosol
	Dispose of product and packaging in an environmentally friendly manner
	Perform the filling in just one short burst.
	The packaging is made of paper and can be disposed of in the wastepaper bin.
	The "GS" symbol stands for verified safety. Products that are marked with this symbol meet the requirements of the German product safety law (ProdSG).

Introduction

Congratulations on the purchase of your new product. You have chosen a high quality quality product with this purchase. These operating instructions form an integral part of this product. They contain important instructions on safety, use and disposal of the product. Please familiarise yourself with all operating and safety instructions before using the product. Important: Read these instructions carefully so as to familiarise yourself with the product before filling it with gas. Keep these instructions for future reference. Use the product only as described and for the specified areas of application. If the product is passed on to a third party, please provide all documents to the third party together with the product.

Safety instructions



- **WARNING! Please keep the gas soldering iron out of reach of children.**
- **Wear eye protection to avoid the risk of eye injuries.**
- **Contains flammable pressurised gas.** Take care not to heat the refillable gas tank. Do not expose gas soldering iron to temperatures exceeding 50 °C/120 °F or to prolonged sunlight. Otherwise there is risk of disintegration or explosion.
- **Never operate the device if any part is damaged.**
- **Do not make any changes to the gas soldering iron! The soldering iron may not be modified in any way. Factory settings may not be altered. Only replacement parts recommended by the manufacturer may be used.** It can be dangerous to modify or adjust the gas soldering iron, to remove factory fitted parts or to use replacement parts other than those recommended by the manufacturer.
- **WARNING! Risk of flash fire in case the gas tank is filled improperly and/or overfilled. Read the refill instructions before filling the tank and follow the described procedure exactly.**
- **Do not pierce, open or expose the unit to fire.** Otherwise there is risk of disintegration or explosion.
- To avoid the risk of damage to the soldering iron, **do not allow it to fall on to the floor** – never use a gas soldering iron which shows signs of damage.
- **Never use the device if it is not airtight, if it is damaged or if it does not function properly.**
- **If gas escapes from the system (smell of gas), take the system outdoors immediately to a well-ventilated location away from sources of ignition where the leak can be safely detected and repaired. Carry out the leak test in the open only. Do not try to detect leaks using a flame, use a gas leak detector spray or soapy water.** There is risk of fire or explosion in case of a leak. - Contact the manufacturer or retailer in case of a leak. Have repairs carried out only by authorised specialist dealers or by the manufacturer.
- **Work in a fire resistant environment or in the open.** Otherwise there is danger of fire, explosion or suffocation.
- **Always use a heat-resistant and fireproof surface.**
- **Extreme heat is generated above the device. Take special care to avoid burns or fire hazards.**
- **When mounting the hot air attachment, make sure that the lateral outlet opening (16) points upwards.** Otherwise the work table or the workpiece may be damaged by the escaping heat.

- **Use the burner only at a clean workplace, well away from inflammable materials, walls or ceilings or oily materials. The soldering iron may not be used in an environment where flammable fumes, flammable liquids or explosive materials are present.** Otherwise there is risk of fire or explosion.
- **WARNING: The gas soldering iron should not be ignited near the face, hands, clothing or inflammable material and the flame should not be directed at others.** Otherwise there is risk of burns. Maintain a safe distance of min. 0.5 m on the side from all objects, as well as a min. distance of 1 m from objects over the device.
- **The air vents on the soldering attachment give off hot air. Ensure that the gas soldering iron is always placed on the integrated stand even during short breaks, to avoid igniting the table surface or other objects. Do not direct the hot air vents towards your eyes, face or others.** Otherwise there is risk of burns.
- **Do not inhale the welding/soldering fumes,** as they can be poisonous.
- **Be aware that the actual size of the flame can be longer than it appears to be.** The flame may hardly be visible under certain light conditions – danger of burning!
- **The burner nozzle, the firing tips and the hot air gun become hot during operation and remain very hot immediately after the flame has gone out.** Take care to protect yourself from accidental burns. Do not touch the torch tips!
- **Ensure that the flame is extinguished completely after use and wait till the soldering iron has cooled completely before storing the iron.** Otherwise there is risk of fire.

Intended use

This gas soldering iron set is designed for soft soldering electrical wires and circuit boards, removing or drying paint and forming plastic.

It is also suitable for shrink-fitting and softening and removing adhesives.

The soldering iron set may be used for only in accordance with its intended purpose. Any other use is forbidden. The manufacturer cannot be held responsible for damage or injury caused by use the machine for other than its intended purpose.

It may be used only for attachments appropriate for the gas soldering iron set. Non-observance of the safety, assembly and operating instructions while operating the machine counts as misuse.

Persons operating the gas soldering iron and undertaking maintenance activities must be familiar with them and informed of the possible dangers. Any applicable health and safety regulations must also be followed.

Any other applicable local and national legislation must also be followed. The manufacturer cannot accept any responsibility for damage or injury caused by modifications to the gas soldering iron.

The gas soldering iron set has not been designed for professional, trade or industrial use, but for private users in the hobby and DIY sector.

All other applications are expressly ruled out and are considered as unintended use.

Technical specifications

Pack contents

- Gas soldering iron
- Protective cap
- 4 soldering tips (1x pre-assembled)
- Hot air deflector
- Cleaning sponge
- Solder
- Fuel gas cartridge ROTHENBERGER INDUSTRIAL Refill Super 100

Description of the parts

- 1 Hot air/soldering attachment
- 2 Soldering torch attachment
- 3 Knurled nut
- 4 Switch for continuous flame
- 5 Flame controller (infinitely variable - smallest flame  largest flame)
- 6 Refill valve
- 7 Ignition switch/columns
- 8 Solder wire
- 9 Cleaning sponge
- 10 Soldering tips , round
- 11 Soldering tips, long form
- 12 Soldering tips , chisel form
- 13 Pointed soldering tip
- 14 Hot air deflector
- 15 Protective cap
- 16 Outlet opening
- 17 Refill adapter (supplied with canister)

Technical data

Distributor: Walter Werkzeuge Salzburg GmbH, Gewerbeparkstr. 9, 5081 Anif, Austria

Name of the product: Gas soldering iron mod. No. WWS-GLK9-Y02

The gas soldering iron is not filled.

Appliance category / type of gas:	Direct pressure butane; Direct pressure Butane-propane mixture (propane: max. 25%) This product should only be operated with the Refill Super 100 canister or with equivalent canisters with the label 'butane' or 'butane-propane mixture'. It may be hazardous to attempt to use other types of gas canisters.
Max. flame temperature:	Gas torch 1,300°C Hot air 600°C Soldering 450°C
Usage:	Use only outdoors or in well ventilated rooms. Follow the national requirements for the supply of combustion air.
Fuel consumption:	approx. 6.9 g/h

Before using the tool

Check the gas soldering iron and scope of delivery

- Take the gas soldering iron and accessories out of the packaging.
- Check if the delivery is complete (see section “SCOPE OF DELIVERY / DESCRIPTION OF PARTS”).
- Check whether the gas soldering iron or the accessories are damaged.
- Do not use the gas soldering iron if it is damaged or parts are missing. Contact the manufacturer via the service centre.

Filling the gas tank (Figure A-C)



CAUTION! Danger of fire, burning and/or explosion!

- Fill the gas tank only in a well ventilated location, preferably outside, away from any sources of ignition, such as open flames, pilot flames, or electric cooking appliances and away from other people.
- Turn off the gas soldering iron, make sure the flame is off and do not fill the gas tank until the gas soldering iron has cooled down completely.
- Do not smoke while filling the gas tank or while using the gas soldering iron.



CAUTION! Risk of flash fire in case the gas tank is filled improperly and/or overfilled.

- Strictly follow the procedure described below.

The best results are achieved with the butane-propane mix Refill Super 100. Alternatively, even commercial lighter gas (butane) can be used. Make sure you insert the adapter supplied with the gas canister onto the canister nozzle.

1. If necessary, empty the gas tank by igniting the gas soldering iron and burning off any remaining gas.
2. Allow the gas soldering iron to cool down completely.
3. Insert the adapter supplied with the gas canister with side slots (17) onto the canister nozzle.
4. Place the nozzle of the gas canister on the refill valve (6) of the gas soldering iron and press it. Carry out the filling in just **one short burst (max. 1 second)** and stop filling as soon as gas flows out of the nozzle.
5. Remove the nozzle of the gas refill canister out of the refill valve of the soldering iron as soon as the gas begins to flow out. Overfilling the tank will cause the flame to spit.
6. Wait for at least five minutes each time after filling before igniting the iron for the first time to allow the gas to stabilise.
7. As with any gas tool, be careful when using the soldering iron.



Operation/use

Assembly of attachments(Figure D)



CAUTION: Accessible parts may become very hot. Keep small children away from the product.

One hot air attachment (1), one torch attachment (2), four soldering tips (10-13) and one hot air deflector (14) are included in the contents. To fit the various attachments, proceed as described on the following pages.

Use as soldering iron (Figure E)

The gas soldering iron is provided with the blow torch attachment, hot air/soldering attachment and with a soldering tip can be used as soldering iron.



CAUTION! Danger of burns! Allow the gas soldering iron to cool completely before changing the attachments.

- 4 soldering tips are included in the contents.
- Choose the most suitable tip for your application and screw this firmly into the threaded hole in the hot air/soldering attachment. The pre-assembled soldering tip should be removed beforehand as required.

Use as hot air gun (Figure F)

The hot air gun function is ideal for removing or drying paint and forming plastic. It can also be used for shrink fitting and softening or removing adhesive.



CAUTION! Danger of burns! Allow the gas soldering iron to cool completely before changing the attachments.

- Detach the soldering tip from the hot air/soldering attachment.
- The soldering iron can now be used as a hot air gun.

Hot air deflector (Fig. G)

The hot air deflector can be used with the hot air attachment. This is helpful e.g. when shrinking cables.



CAUTION! Danger of burns! Never touch the heated hot air deflector. Allow the gas soldering iron to cool completely before changing the attachments.

- Push the hot air deflector firmly on the hot air attachment. The mounted hot air deflector can now be turned as required.

Use as blowing torch (Figure H)

Assembly

- Loosen the knurled nut (3).
- Remove the hot air/soldering attachment from the torch.
- Fix the blow torch attachment with the help of the knurled nut on the device.
- The device can now be used as a blow torch.

Igniting and extinguishing the flame

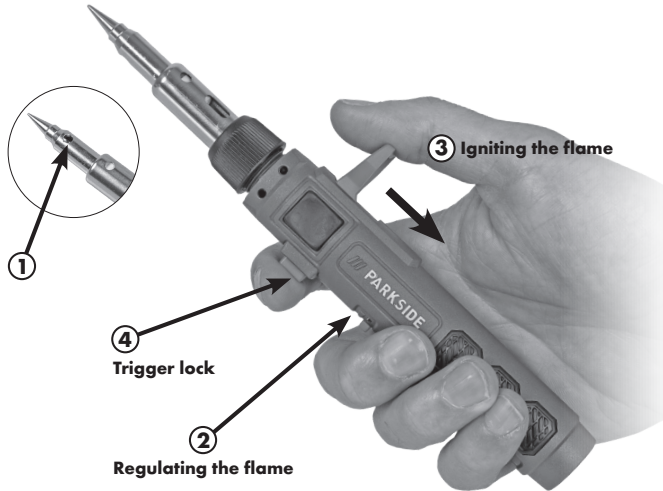

1. Outlet opening

- Applies only for use as a heat gun or gas soldering iron: Before starting work, check that the side outlet of the hot air attachment (16) points upwards (= away from the stand). Adjust the position of the hot air attachment if necessary.

2. Push the flame regulator (5) to the highest position

3. Periodic operation

- Pull the ignition switch (7) to ignite the flame.
- Release the ignition switch to extinguish the flame.

4. Permanent operation

- Pull the ignition switch to ignite the flame.
- Press the continuous operation switch (4) to lock the ignition switch in the drawn position.
- Pull the ignition switch (7) again and then release it immediately to release the continuous operation switch and extinguish the flame.

5. Flame controller

- The iron is provided with a flame controller (5). The flame controller is marked with the symbol .
- Slide the flame controller left for minimum level and right for maximum level.
- Slide the flame controller to maximum position before igniting the burner.

An irregular flame can be generated or gas can escape in fluid form if the gas soldering iron is cold or has just been refilled. This is normal and does not indicate a fault. The flame will stabilise once the device warms up (approx. 1-2 minutes).

Shutting down the product safely (Figure I)

A stand is integrated in the ignition switch to rest the device safely. Always use the tool rest when putting the item down.

Protective cap (Figure J)

The contents include a protective cap (15). Use the protective cap to safely rest the hot device and to prevent mechanical hazards.



CAUTION! Danger of fire! The protective cap must not be fitted when the flame is ignited.

CAUTION! Danger of burns! The metal attachments become extremely hot during normal operation.

- Slide the protective cap firmly on the locking nut.

Storage conditions

- If the soldering iron set is not to be used keep it at a safe, cool, dry and well-ventilated place out of the reach of children.
- Store the device in the storage box intended for it, when possible. However, allow it to cool completely before storage.

Cleaning and maintenance



Caution! Allow the gas soldering iron to cool completely before performing any cleaning or maintenance work. To avoid damage, do not use aggressive cleaning material, metal brushes or sharp objects such as knives, etc.

- The gas soldering iron is practically maintenance-free. However, the tip wears out after some time and needs to be replaced, as described in the "Replacing the attachments assembly" chapter.
- Only use spare parts/accessories from the manufacturer.
- Have repairs carried out only by authorised specialist dealers or by the manufacturer. More information can be found in the "Guarantee" chapter.
- Clean the device with a soft, slightly damp cloth if required. Ensure that no moisture enters the device.
- Clean the soldering tips using the cleaning sponge included in the supply.

Troubleshooting

Problem	Possible cause	Rectification
The soldering iron doesn't switch on.	The tank is empty.	Fill the tank as per the gas tank filling instructions.
	The flame size is not sufficient.	Slide the flame controller to increase the flame size.
The solder does not run smoothly on the soldering iron.	The tank is empty.	Fill the tank as per the gas tank filling instructions.
	The flame size is not sufficient.	Slide the flame controller to increase the flame size.
The soldering tip is not hot.	The soldering tip did not have enough time to heat up.	Some soldering tips take longer to heat up. Please be patient
The flame is not visible.	The flame is only visible in the burning position.	See chapter "Use as a blow torch"

Disposal



The gas soldering iron may only be disposed of when empty. Worn out tools must be recycled at a suitable recycling facility. Do not dispose of with the household waste. For further information contact your local authority. Dispose of the packaging material according to the type of material and according to any local regulations.

Instructions for disposal of the gas cartridge

Do not dispose of with the household waste. For further information contact your local authority.

Pressurised container: Do not puncture or incinerate, even after use. Do not open forcefully or incinerate even after use.

Warranty

Warranty provided by Walter Werkzeuge Salzburg GmbH

Dear customer,

This device comes with a 3 year warranty from the date of purchase. In case of defects in the product you may be entitled to legal claims against the seller of the product. These legal claims are not restricted by the following warranty.

Conditions of warranty

The warranty period begins with the date of purchase. Please preserve the original sales receipt. This document is required as proof of purchase. If a material or fabrication defect occur in this product within three years from the date of purchase, the product shall be repaired or replaced free of cost at our discretion. Within the three year period the warranty requires the defective product and the purchase document (sales receipt) to be provided with a brief written description of where the defect lies and when it occurred.

If the defect is covered by our warranty, the repaired product or a new product shall be returned to you. A new warranty period does not begin with the repair or exchange of the product.

Warranty period and legal claims based on defects

The warranty period is not extended by the warranty. This also applies to replaced and repaired parts. Any damages and defects that may exist at the time of purchase must be notified immediately after removal from packaging. Any repairs arising after the expiry of the warranty period are chargeable.

Scope of the warranty

The device has been manufactured according to strict quality guidelines and tested diligently before delivery. The warranty applies to material or fabrication defects. This warranty does not cover product parts that are subject to normal wear and tear and therefore can be considered as parts subject to wear and tear or for the damage to fragile parts, e.g. switch, batteries or those made of glass.

This warranty is void if the product is damaged, not used or maintained properly. All the instructions provided in the operating manual must be followed exactly for proper use of the product. The purpose of use and actions which are advised or warned against must necessarily be avoided.

The product is intended solely for private use and not for professional use. The warranty is void in case of misuse or improper handling, use of force and changes that have not been carried out by our authorised service centre.

Processing a warranty case

To ensure quick processing of your issue, please follow the below instructions:

- Please be ready with the sales receipt and the product number (e.g. IAN 12345) as proof of purchase for all queries.
- You can refer the product number from the type label, an engraving, on the cover sheet of your operating instructions (below left) or as sticker on the back or lower side.
- If functional or other defects occur, first call or email the following service department.
- You can then send a product recorded as defective postage free along with the sales receipt and information about where the defect lies and when it has occurred, to the service centre address provided to you.

This and many other manuals, product videos and software can be downloaded at www.lidl-service.com

Service



Walter Werkzeuge Salzburg GmbH
E-Mail: service-uk@walteronline.com
Tel.: 00800 925 837 88

IAN 373546_2104

Supplier:

Please note that the following address is not a service centre address. Please contact the above-mentioned service centre first.

Walter Werkzeuge Salzburg GmbH
Gewerbeparkstr. 9
5081 Anif, Austria

Walter Werkzeuge Salzburg GmbH

Gewerbeparkstr. 9
5081 Anif, AUSTRIA

V. 1.0

Last Information Update:
02/2022

IAN 373546_2104